

MaxiTPMS ITS600E



Trademarks

Autel®, MaxiSys®, MaxiDAS®, MaxiPRO®, MaxiRecorder®, MaxiCOM®, MaxiTPMS®, and MaxiCheck® are trademarks of Autel Intelligent Technology Corp., Ltd., registered in China, the United States, and other countries. All other marks are trademarks or registered trademarks of their respective holders.

Copyright Information

No part of this manual may be reproduced, stored in a retrieval system or transmitted in any form or by any means electronic, mechanical, photocopying, recording, or otherwise without the prior written permission of Autel.

Disclaimer of Warranties and Limitation of Liabilities

All information, specifications and illustrations in this manual are based on the latest information available at the time of printing.

Autel reserves the right to make changes at any time without notice. While information of this manual has been carefully checked for accuracy, no guarantee is given for the completeness and correctness of the contents, including but not limited to the product specifications, functions, and illustrations.

Autel will not be liable for any direct, special, incidental, or indirect damages, or for any economic consequential damages (including the loss of profits) as a result of using this product.

IMPORTANT

Before operating or maintaining this unit, please read this manual carefully, paying extra attention to the safety warnings and precautions.

For Services and Support



pro.autel.com

www.autel.com

www.maxitpms.com



+86 (0755) 8614-7779

Safety Information

For your own safety and the safety of others, and to prevent damage to the device and vehicles upon which it is used, it is important that the safety instructions presented throughout this manual be read and understood by all persons operating or coming into contact with the device.

There are various procedures, techniques, tools, and parts required for servicing vehicles, as well as the skills of the person doing the work. Because of the vast number of test applications and variations in the products that can be tested with this equipment, we cannot possibly anticipate or provide advice or safety messages to cover every circumstance. It is the automotive technician's responsibility to be knowledgeable of the system being tested. It is crucial to use proper service methods and test procedures. It is essential to perform tests in an appropriate and acceptable manner that does not endanger your safety, the safety of others in the work area, the device being used, or the vehicle being tested.

Before using the device, always refer to and follow the safety messages and applicable test procedures provided by the manufacturer of the vehicle or equipment being tested. Use the device only as described in this manual. Be sure to read, understand, and follow all safety messages and instructions in this manual.

Safety Messages

Safety messages are provided to help prevent personal injury and equipment damage. All safety messages are introduced by a signal word indicating the hazard level.

DANGER

Indicates an imminently hazardous situation which, if not avoided, will result in death or serious injury to the operator or to bystanders.

WARNING

Indicates a potentially hazardous situation which, if not avoided, could result in death or serious injury to the operator or to bystanders.

Safety Instructions

The safety messages herein cover situations Autel is aware of at the time of publication. Autel cannot know, evaluate or advise you as to all of the possible hazards. You must be certain that any condition or service procedure encountered does not jeopardize your personal safety.

 **DANGER**

When an engine is operating, keep the service area WELL VENTILATED or attach a building exhaust removal system to the engine exhaust system. Engines produce carbon monoxide, an odorless, poisonous gas that causes slower reaction time and can lead to serious personal injury or loss of life.

 **SAFETY WARNINGS**

- Always perform automotive testing in a safe environment.
- Wear safety eye protection that meets ANSI standards.
- Keep clothing, hair, hands, tools, test equipment, etc. away from all moving or hot engine parts.
- Operate the vehicle in a well-ventilated work area, for exhaust gases are poisonous.
- Put the transmission in PARK (for automatic transmission) or NEUTRAL (for manual transmission) and make sure the parking brake is engaged.
- Put blocks in front of the drive wheels and never leave the vehicle unattended while testing.
- Be extra cautious when working around the ignition coil, distributor cap, ignition wires and spark plugs. These components create hazardous voltages when the engine is running.
- Keep a fire extinguisher suitable for gasoline, chemical, and electrical fires nearby.
- Do not connect or disconnect any test equipment while the ignition is on or the engine is running.
- Keep the test equipment dry, clean, free from oil, water or grease. Use a mild detergent on a clean cloth to clean the outside of the equipment as necessary.
- Do not drive the vehicle and operate the test equipment at the same time. Any distraction may cause an accident.
- Refer to the service manual for the vehicle being serviced and adhere to all diagnostic procedures and precautions. Failure to do so may result in personal injury or damage to the test equipment.
- To avoid damaging the test equipment or generating false data, make sure the vehicle battery is fully charged and the connection to the vehicle DLC is clean and secure.
- Do not place the test equipment on the distributor of the vehicle. Strong electromagnetic interference can damage the equipment.

CONTENTS

1 USING THIS MANUAL	1
1.1 CONVENTIONS	1
1.1.1 Bold Text.....	1
1.1.2 Notes and Important Messages	1
1.1.3 Hyperlinks	1
1.1.4 Illustrations.....	2
1.1.5 Procedures.....	2
2 GENERAL INTRODUCTION	3
2.1 MAXITPMS ITS600E TABLET	3
2.1.1 Function Description	3
2.1.2 Power Sources.....	5
2.1.3 Technical Specifications.....	5
2.2 VCI – VEHICLE COMMUNICATION INTERFACE.....	6
2.2.1 Technical Specifications.....	8
2.3 OTHER ACCESSORIES	8
3 GETTING STARTED	9
3.1 POWERING UP.....	9
3.1.1 Status Information Bar	9
3.1.2 Application Buttons	10
3.1.3 Locator	11
3.1.4 System Status Icons	12
3.2 POWERING DOWN.....	13
3.2.1 Reboot System	13
4 TPMS	14

4.1	ESTABLISHING VEHICLE COMMUNICATION.....	14
4.1.1	Vehicle Connection	14
4.1.2	VCI Connection.....	14
4.1.3	No Communication Message	15
4.2	GETTING STARTED.....	16
4.2.1	TPMS Service Menu Layout	16
4.3	VEHICLE IDENTIFICATION	18
4.3.1	Auto VIN Detect	18
4.3.2	Scan License	18
4.3.3	Scan VIN.....	20
4.3.4	Manual Input	20
4.4	TPMS CHECK.....	25
4.5	TPMS DIAGNOSTICS.....	27
4.5.1	Diagnosis Operations.....	27
4.6	SENSOR PROGRAMMING.....	32
4.6.1	Copy by Activation	33
4.6.2	Copy by OBD	35
4.6.3	Copy by Input.....	36
4.6.4	Auto Create	37
4.7	TPMS RELEARN.....	38
4.7.1	OBD Relearn.....	38
4.7.2	Automatic Relearn	40
4.7.3	Stationary Relearn	41
4.8	RETROFIT.....	42
4.9	WEAR DETECTION	42
4.9.1	Function Operations.....	43

4.9.2	Check Mode	45
4.9.3	Details	49
5	TPMS RETROFIT	52
5.1	RETROFIT.....	52
6	BATTERY TEST	54
6.1	MAXIBAS BT506 BATTERY TESTER.....	54
6.1.1	Function Description	54
6.1.2	Power Sources.....	55
6.1.3	Technical Specifications.....	56
6.2	TEST PREPARATION	56
6.2.1	Inspect the Battery	56
6.2.2	Connect the Battery Tester	56
6.3	IN-VEHICLE TEST.....	57
6.3.1	Battery Test.....	58
6.3.2	Starter Test	62
6.3.3	Generator Test.....	64
6.4	OUT-VEHICLE TEST	65
6.4.1	Battery Test.....	65
7	OE ENTRY	67
7.1	TPMS BY OEM PART NO.	67
7.1.1	Application Scenarios	67
7.1.2	Function Operations.....	67
8	DIAGNOSTICS.....	72
8.1	GETTING STARTED.....	72
8.1.1	Vehicle Menu Layout	72
8.2	VEHICLE IDENTIFICATION	73

8.2.1	Auto VIN Scan	73
8.2.2	Manual VIN Input	75
8.2.3	Automatic Selection	76
8.2.4	Manual Selection	77
8.3	NAVIGATION	78
8.3.1	Diagnostics Screen Layout	78
8.3.2	Screen Messages	79
8.3.3	Making Selections.....	79
8.4	DIAGNOSTICS FUNCTIONS.....	79
8.4.1	Auto Scan Operation.....	80
8.4.2	ECU Information	83
8.4.3	Read Codes	83
8.4.4	Erase Codes	84
8.4.5	Live Data.....	85
8.5	GENERIC OBDII OPERATIONS.....	87
8.5.1	General Procedure.....	87
8.5.2	Function Descriptions	89
8.6	EXITING DIAGNOSTICS.....	91
9	SERVICE.....	93
9.1	OIL RESET SERVICE.....	93
9.2	ELECTRIC PARKING BRAKE (EPB) SERVICE	94
9.2.1	EPB Safety.....	94
9.3	BATTERY MANAGEMENT SYSTEM (BMS) SERVICE	94
9.4	STEERING ANGLE SENSOR (SAS) SERVICE.....	95
10	TIRE DOT.....	96
11	SETTINGS.....	99

11.1	TPMS MARKET	99
11.2	TPMS PROG. SETTING.....	99
11.3	TBE MANAGER	99
11.4	VCI MANAGER	100
11.4.1	Bluetooth Connection	101
11.4.2	VCI Firmware Upgrade.....	102
11.5	SYSTEM SETTINGS	102
11.6	PRINTER MANAGER	102
11.7	REPORT UPLOAD TO CLOUD.....	102
11.8	UNIT	103
11.9	ABOUT	103
12	TOOLKIT	104
13	UPDATE	105
13.1	TABLET UPDATE.....	105
14	DATA MANAGER.....	107
14.1	TEST RECORDS.....	108
14.1.1	TPMS Test Report.....	109
14.2	WORKSHOP INFORMATION.....	111
14.3	IMAGE	112
14.4	PDF	113
14.5	REPORT	114
14.6	UNINSTALL APPS.....	114
14.7	DATA LOGGING	114
15	ACADEMY.....	117
16	REMOTE DESKTOP	118
17	MAXITOLS	119

17.1	SYSTEM TOOLS.....	119
17.2	QUICK LINK.....	119
17.3	EMAIL.....	120
18	ACTIVATE PRO FUNCTION	121
19	MAINTENANCE AND SERVICE	122
19.1	MAINTENANCE INSTRUCTIONS.....	122
19.2	TROUBLESHOOTING CHECKLIST	122
19.3	ABOUT BATTERY USAGE	123
19.4	SERVICE PROCEDURES.....	124
19.4.1	Technical Support	124
19.4.2	Repair Service.....	125
19.4.3	Other Services.....	125
20	COMPLIANCE INFORMATION.....	126
21	WARRANTY	128

1 Using This Manual

This manual contains device usage instructions.

Some illustrations shown in this manual may make reference to modules and optional equipment that are not included in your system. Contact Autel's technical support for availability of other modules and optional tools or accessories.

1.1 Conventions

The following conventions are used:

1.1.1 Bold Text

Bold text is used to highlight selectable items such as buttons and menu options.

Example:

- Tap **OK**.

1.1.2 Notes and Important Messages

1.1.2.1 Notes

A **NOTE** provides helpful information such as additional explanations, tips, and comments.

1.1.2.2 Important

IMPORTANT indicates a situation which, if not avoided, may result in damage to the test equipment or vehicle.

1.1.3 Hyperlinks

Hyperlinks are available in electronic documents. Blue italic text indicates a selectable hyperlink; blue underlined text indicates a website link or an email address link.

1.1.4 Illustrations

Illustrations used in this manual are samples; the actual testing screen may vary for each vehicle being tested. Observe the menu titles and on-screen instructions to make correct option selection.

1.1.5 Procedures

An arrow icon indicates a procedure.

Example:

- **To power down the tablet**
 1. Long press the **Power/Lock** button.
 2. Tap the **Power Off** option.
 3. Tap **OK**. The tablet will turn off in a few seconds.

2 General Introduction

There are two main components of ITS600E system:

- MaxiTPMS ITS600E Tablet — the central processor and monitor for the system.
- MaxiVCI V200E — Vehicle Communication Interface. The device for accessing vehicle data.

This manual describes the construction and operation of both devices and how they work together to deliver diagnostic solutions.

2.1 MaxiTPMS ITS600E Tablet

2.1.1 Function Description

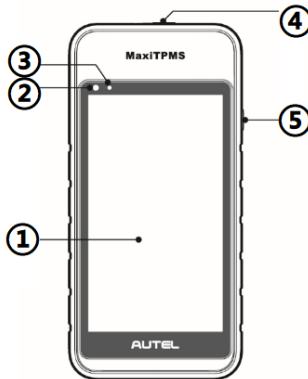

Figure 2-1 MaxiTPMS Tablet Front View

1. 5.5" LCD Capacitive Touchscreen
2. Ambient Light Sensor — detects ambient brightness.
3. Power LED — indicates battery level & charging or system status.
4. TPMS Service Symbol — indicates the position of the embedded TPMS antenna.
5. Power/Lock Button — long press to turn on/off the tablet, or short press to lock the screen.

The power LED displays green or red depending on power level and operating state:

- A. Green
 - Flashes green when the tablet is charging.
 - Illuminates green when the tablet is fully charged.
- B. Red
 - Illuminates red when a problem is detected.

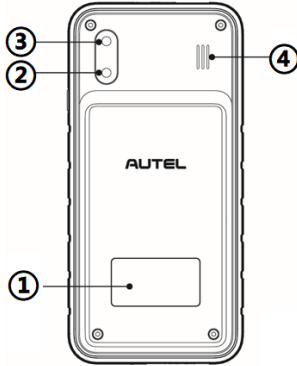

Figure 2-2 MaxiTPMS Tablet Back View

1. Sticker
2. Rear Camera
3. Camera Flash
4. Speaker

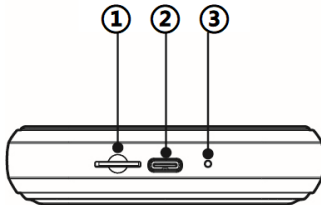

Figure 2-3 MaxiTPMS Tablet Top View

1. Micro SD Card Slot
2. Type-C USB OTG Port
3. Microphone

2.1.2 Power Sources

The tablet can receive power from any of the following sources:

- Internal Battery Pack
- AC/DC Power Supply
- Vehicle Power Supply

2.1.2.1 Internal Battery Pack

The tablet can be powered with the internal rechargeable battery, which if fully charged can provide sufficient power for about 7 hours of continuous video watching and 5 hours of operations.

2.1.2.2 AC/DC Power Supply

The tablet can be powered from a wall socket using the AC/DC power adapter that connects to the Type-C USB cable. The AC/DC power supply also charges the internal battery pack.

2.1.2.3 Vehicle Power

The tablet can be powered from the auxiliary power outlet adapter or other suitable power port on the test vehicle through a direct cable connection. The vehicle power cable connects to the USB Type-C port at the bottom of the tablet for charging.

2.1.3 Technical Specifications

Table 2-1 Specifications

Item	Description
Recommended Use	Indoor
Operating System	Android 9.0
Processor	Quad-core processor (1.5 GHz)
Memory	2 GB RAM DDR4 & 64 GB ROM
Display	5.5-inch LCD capacitive touchscreen with 1280 x 720 resolution
Rear Camera	8 MP

Item	Description
Connectivity	<ul style="list-style-type: none"> ● Wi-Fi ● Type-C USB ● Bluetooth
Sensor	Light sensor for brightness auto adjustment
Audio Input/Output	<ul style="list-style-type: none"> ● Input: Microphone ● Output: Speaker
Power and Battery	<ul style="list-style-type: none"> ● 3.8 V/5000 mAh lithium-polymer battery ● Charges via 5 V DC power supply
Battery Charging Input	5 V/2 A
Power Consumption	700 mA (LCD on with default brightness, Wi-Fi on) @3.8 V
Operating Temp.	0 °C to 50 °C (32 °F to 122 °F)
Storage Temp.	-20 °C to 60 °C (-4 °F to 140 °F)
Dimensions (W x H x D)	183.0 mm (7.2") x 89.0 mm (3.5") x 22.0 mm (0.87")
Net Weight	368 g (0.8 lb.)
Protocols	ISO9141-2, ISO14230-2, ISO15765, K/L-Line, Flashing Code, SAE-J1850 VPW, SAE-J1850PWM, ISO11898 (Highspeed, Middlespeed, Lowspeed and Singlewire CAN, fault-tolerant CAN), SAE J2610, GM UART, UART Echo Byte Protocol, Honda Diag-H Protocol, TP2.0, TP1.6, ISO 13400, CAN FD

2.2 VCI – Vehicle Communication Interface

The MaxiVCI V200E is a small vehicle communication interface (VCI) used to connect to a vehicle's DLC and the tablet for vehicle data transmission.

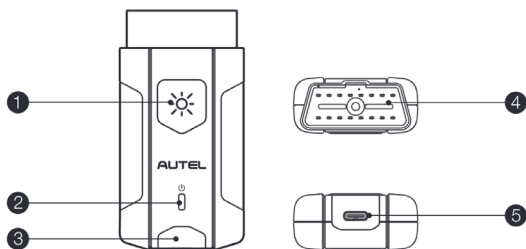

Figure 2-4 MaxiVCI V200E Views

1. Flashlight Power Button
2. Power LED — refer to [Table 2-2 VCI LED Description](#) for details
3. Vehicle/Connection LED — refer to [Table 2-2 VCI LED Description](#) for details
4. Vehicle Data Connector (16-pin)
5. USB Port

Table 2-2 VCI LED Description

LED	Color	Description
Power LED	Yellow	The VCI is powered on and performing self-check.
	Green	The VCI is ready for use.
	Flashing Red	The firmware is updating.
Vehicle/ Connection LED	Green	<ul style="list-style-type: none"> ● Solid Green: The VCI is connected via USB cable. ● Flashing Green: The VCI is communicating via USB cable.
	Blue	<ul style="list-style-type: none"> ● Solid Blue: The VCI is connected via Bluetooth. ● Flashing Blue: The VCI is communicating via Bluetooth.

NOTE

The power LED briefly lights yellow each time the device powers on and then lights green when the device is ready.

2.2.1 Technical Specifications

Table 2-3 *Technical Specifications*



Item	Description
Communications	<ul style="list-style-type: none">• BLE + EDR• Type-C USB
Wireless Frequency	2.4 GHz
Input Voltage Range	8 V to 30 V DC
Supply Current	150 mA @ 12 V DC
Operating Temp.	0 °C to 50 °C (32 °F to 122 °F)
Storage Temp.	-20 °C to 60 °C (-4 °F to 140 °F)
Dimensions (L x W x H)	89.89 mm (3.53") x 46.78 mm (1.84") x 21 mm (0.82")
Weight	70.7 g (0.156 lb.)
Built-in Battery	3.7 V Lithium Battery
Light	White LED

 **NOTE**

The 3.7 V lithium battery is used for LED lighting only.

2.3 Other Accessories

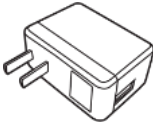
Table 2-4 *Accessories*

	<p>Power Adapter</p> <p>Used with the Type C USB cable to charge the tablet via DC electrical outlet.</p>
	<p>Type C USB Cable</p> <p>Connect to power adapter and the tablet for charging.</p>

3 Getting Started

Ensure the tablet is sufficiently charged or is connected to a power outlet (see [Power Sources](#)).

3.1 Powering Up

Long press the **Power/Lock** button on the right side of the tablet to switch the unit on. The system boots up and displays the MaxiTPMS Job Menu.

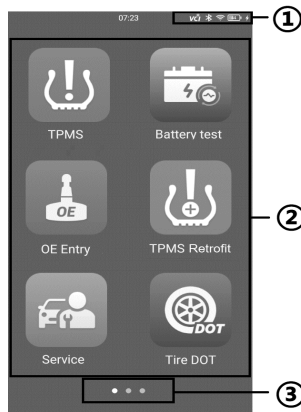

Figure 3-1 MaxiTPMS ITS600E Job Menu

1. Status Information Bar
2. Application Buttons
3. Locator





Almost all operations on the tablet are controlled through the touchscreen. The touchscreen navigation is menu-driven, allowing for quick access to test procedure, or data that you need, through a series of questions and options. Detailed descriptions of the menu structures are found in the chapters for each application.

3.1.1 Status Information Bar

The status information bar varies according to the stage of operations, and may display

the items described in the table below.





Table 3-1 Status Information Bar









Icon	Name	Description
	VCI Status	VCI is displayed at the upper-right corner of the screen when the VCI is not successfully connected to the tablet. After the MaxiVCI V200E is successfully connected to the tablet, the VCI icon is changed to VCI (with a check mark).
	Voltage	Displays the current voltage value of the connected device.
	Wi-Fi	Indicates that Wi-Fi is connected and displays the signal strength.
	Battery Level	Displays the remaining battery power.

3.1.2 Application Buttons

Descriptions of the tool applications are displayed in the table below.

Table 3-2 Applications

Button	Name	Description
	TPMS	Accesses the TPMS service program. See TPMS for details.
	TPMS Retrofit	Allows TPMS to be installed on vehicles. See TPMS Retrofit for details.
	Battery Test	Assesses the battery test menu. See Battery Test for details.
	OE Entry	Accesses OEM menu. See OE Entry for details.

Button	Name	Description
	Diagnostics	Accesses diagnostics functions menu (the diagnostics function is available with an additional purchase). See Diagnostics for details.
	Service	Accesses special functions menu. See Service for details.
	Settings	Accesses MaxiTPMS system settings menu and general tablet menu. See Settings for details.
	ToolKit	Accesses auxiliary functions menu for TPMS service. See ToolKit for details.
	Update	Accesses system software update menu. See Update for details.
	Data Manager	Accesses the organization system for saved data files. See Data Manager for details.
	Academy	Accesses technical tutorials and training articles about the device or vehicle diagnostic techniques. See Academy for details.
	Remote Desktop	Configures your unit to receive remote support using the TeamViewer application. See Remote Desktop for details.
	Activate Pro function	Accesses all system diagnostics and service function. See Activate Pro Function for details.

3.1.3 Locator

The locator icon displays at the bottom of the MaxiTPMS Job Menu. Swipe the screen left or right to view the previous or next screen.











3.1.4 System Status Icons

Slide downward the screen to display Shortcuts Panel and have access to a variety of features. The table below shows each icon and its corresponding feature.

 **NOTE**

The shortcuts buttons will be highlighted when enabled, and dimmed when disabled.

Table 3-3 System Status Icons

Button	Name	Description
	System Settings	Launches the Android system settings interface when pressed.
	Bluetooth	Enables/Disables Bluetooth when pressed.
	WLAN	Enables/Disables Wi-Fi when pressed.
	Flashlight	Turns on/off flashlight when pressed.
	Screenshot	Takes a screenshot of the display.
	Automatic brightness	Adjusts the screen brightness to your surroundings.
	Logger	Posts log collection.
	Restart App	Restarts applications when pressed.
	Camera	Enables photo-taking and recording.
	VCI Manager	Opens the VCI Manager application for VCI connection and upgrade. Refer to VCI Manager for more details.

3.2 Powering Down

All vehicle communications must be terminated before powering off the tablet. A warning message will display if the unit attempts to power off while still connected with the vehicle. Forcing the tablet to power off while the unit is still communicating with the vehicle may lead to ECM problems on some vehicles. Exit TPMS-related or diagnostics applications before powering off.

➤ **To power down the tablet**

1. Long press the **Power/Lock** button.
2. Tap the **Power Off** option.
3. Tap **OK**. The tablet will turn off in a few seconds.

3.2.1 Reboot System

In case of a system crash, long press the **Power/Lock** button and select the **Restart** option to initiate a restart of the system.

4 TPMS

The MaxiTPMS tablet provides an extensive series of TPMS-related services and functions. Quickly identifying vehicle information and easy to operate, the tablet is an ideal choice for technicians to complete TPMS work.

4.1 Establishing Vehicle Communication

Prior to performing the TPMS function, ensure the MaxiTPMS tablet is connected to the test vehicle through the MaxiVCI V200E. To establish a proper vehicle communication between the tablet and the test vehicle, you can perform the following steps:

1. Connect the MaxiVCI V200E to the vehicle's DLC for both communication and power supply.
2. Connect the MaxiVCI V200E to the MaxiTPMS tablet via Bluetooth connection or using a USB-C to USB-C cable (not included).
3. A green "√" mark will be displayed on the VCI status icon, indicating the communication between the MaxiVCI V200E and the MaxiTPMS tablet has been established, and the tablet is ready for vehicle diagnosis.

4.1.1 Vehicle Connection

To connect the MaxiVCI V200E device to the test vehicle, insert the vehicle data connector on the MaxiVCI V200E into the vehicle's DLC which is usually located under the vehicle dashboard, and the MaxiVCI V200E will be automatically powered on.

NOTE

The vehicle's DLC is not always located under the dashboard. Refer to the vehicle's user manual for DLC location.

4.1.2 VCI Connection

After the MaxiVCI V200E device is properly connected to the vehicle, the Power LED illuminates solid green, indicating that it is ready to establish a communication with the MaxiTPMS tablet.

The MaxiVCI V200E device supports two communication methods with the MaxiTPMS tablet: Bluetooth or USB-C to USB-C cable connection.

4.1.2.1 Bluetooth Connection

Bluetooth pairing is recommended as the first choice for the communication between the MaxiTPMS tablet and the MaxiVCI V200E. This is because the Bluetooth connection does not need to repeat the plugging and unplugging procedure which is unavoidable when using traditional wired connection, saving more time and providing higher efficiency. The working range for Bluetooth communication is about 33 feet (about 10 m), enabling remote vehicle diagnostics.

Refer to [Bluetooth Connection](#) for detailed information.

4.1.2.2 USB-C to USB-C Cable Connection

The communication between the MaxiTPMS tablet and the MaxiVCI V200E device can also be established using a USB-C to USB-C cable. However, the USB-C to USB-C cable is not included in the package. If you choose this method to establish a communication between the devices, a USB-C to USB-C cable should be prepared by yourself.

4.1.3 No Communication Message

1. If the MaxiTPMS tablet is not connected to the MaxiVCI V200E correctly, an "Error" message may display. This indicates that the tablet cannot access the vehicle control module. In this case, please do the following check-ups:
 - Check if the MaxiVCI V200E is powered up.
 - Check if the MaxiVCI V200E is properly positioned.
 - Check if the Vehicle/Connection LED on the MaxiVCI V200E is illuminated for Bluetooth or USB-C to USB-C cable connection.
 - In the case of Bluetooth connection, check if the network is configured correctly, or if the right MaxiVCI V200E has been paired up with the MaxiTPMS tablet.
 - ◇ During the diagnosis process, if the communication is suddenly interrupted due to the loss of signal, check if there is any object that causes signal interruption.
 - ◇ Try standing closer to the MaxiVCI V200E to obtain more stable signals and faster communication speed.
 - In the case of USB-C to USB-C cable connection, check the cable connection between the MaxiTPMS tablet and the MaxiVCI V200E.
2. If the MaxiVCI V200E is unable to establish a communication link, a prompt message displays with check instructions. The following conditions are the possible causes:
 - The MaxiVCI V200E is unable to establish a communication link with the vehicle.
 - The system selected for testing is not equipped on the vehicle.

- There is a loose connection.
- There is a blown vehicle fuse.
- There is a wiring fault of the vehicle or the adapter.
- There is a circuit fault in the adapter.
- Incorrect vehicle identification was entered.

4.2 Getting Started

4.2.1 TPMS Service Menu Layout

Tap **TPMS** on the MaxiTPMS Job Menu to access the Vehicle Identification screen.

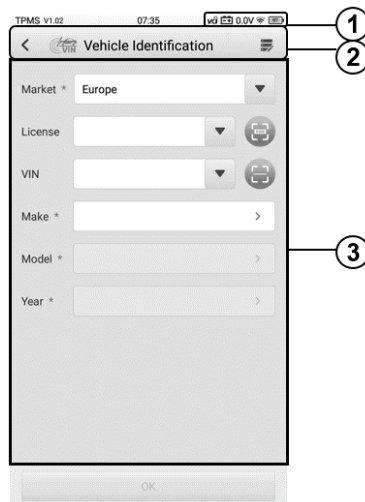





Figure 4-1 Vehicle Identification Screen

1. Status Information Bar — refer to [Table 3-1 Status Information Bar](#) for details.
2. Top Toolbar Buttons — refer to [Table 4-1 Top Toolbar Buttons on Vehicle Menu](#) for details.
3. TPMS Service Access Methods

4.2.1.1 Top toolbar buttons



The operations of the toolbar buttons at the top of the screen are described in the table below.

Table 4-1 Top Toolbar Buttons on Vehicle Menu

Button	Name	Description
	Exit	Returns to the MaxiTPMS Job Menu.
	Auto VIN Detect	Automatically acquire the Vehicle Identification Number (VIN) information, vehicle make, model, and year. See Auto VIN Detect for details.
	Data Logging	Use this function when encountering an error when testing or diagnosing a vehicle. This function will record the communication data and ECU information of the test vehicle and send it to Autel's technical staff to review and provide solution. See Data Logging for details.

4.2.1.2 TPMS Service Access Methods

There are six options available on the screen when accessing the Vehicle Identification page to select the vehicle tested.

- **Market**
Select the market where the user resided, featuring the Europe, North America, Korea, Japan, and Australia market.
- **License**
Tap  to scan license plate number or manually input the plate number.
- **VIN**
Tap  to perform the VIN Scan method or manually input VIN code to identify your vehicle make/model/year.
- **Make**
Tap the blank bar to the right, then the screen displays a list of vehicle manufacturers in alphabetic order. Select the auto manufacturer of your tested vehicle.
- **Model**
Select the specific vehicle model of your vehicle from a list of models displayed.

- **Year**

Select the model year you want to search for the vehicle.

 **NOTE**

The red asterisk icons on the top-right corner of the optional headings indicate mandatory vehicle information to be acquired.

4.3 Vehicle Identification

There are four methods available for acquiring VIN information: Auto VIN Detect, Scan License, Scan VIN, and Manual Input.

4.3.1 Auto VIN Detect

Auto VIN Detect function is used to quickly identify the test vehicle. Before operating, make sure a communication link is established between the test vehicle and the tablet via the MaxiVCI V200E. Refer to [Establishing Vehicle Communication](#) for details.

Or, manually input on the Vehicle Identification screen and follow the on-screen instructions to select the vehicle make, model, and year. This function is compatible with 1998 and newer vehicles.

4.3.2 Scan License

Tap  on the right side of the screen. The camera will be opened. Place the tablet to align the license number within the scanning window. The result displays in the Recognition result dialog box after scanned. Tap **OK** to confirm the result. Once the license number is successfully detected, the screen will automatically jump to the Vehicle Identification page with the license number scanned displays.

 **NOTE**

The method of Scan License is supported in some countries and areas. Please manually input the license number if it is not available.

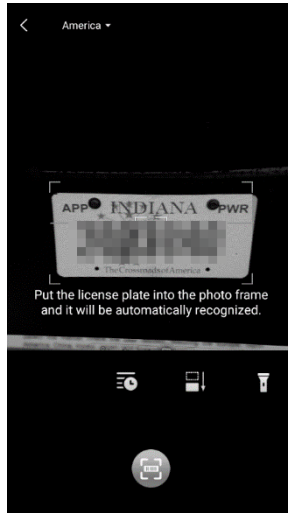



Figure 4-2 Scan License Screen 1



Figure 4-3 Scan License Screen 2

4.3.3 Scan VIN

➤ **To perform Scan VIN**

1. Tap  to perform the Scan VIN method. The camera will be opened.
2. At the bottom of the screen, from left to right, two options are available, **Barcode/QR code Scan** and **Scan VIN**.
3. Select one of two options and position the tablet to align the VIN code within the scanning window. The result displays in the Recognition result dialog box after scanned. Tap **OK** to confirm the result. Once the VIN code is successfully detected, the screen will automatically jump to the Vehicle Identification page with the VIN code acquired displays.

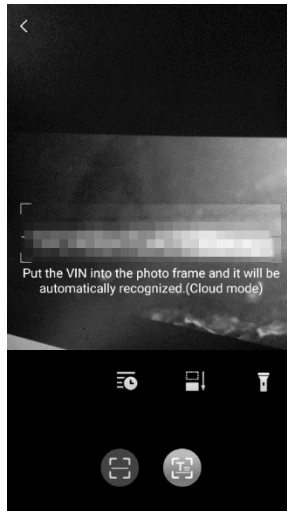

Figure 4-4 Scan VIN Screen

4.3.4 Manual Input

For vehicles that do not support scanning function, the MaxiTPMS system allows you to enter the vehicle VIN or license number manually, or simply take a photo of the VIN sticker or license plate for quick vehicle identification.

➤ **To perform Manual Input**

1. Tap the **TPMS** application button from the MaxiTPMS Job Menu. The Vehicle Identification screen displays.
2. Select **License** or **VIN**, and tap the corresponding input box on the screen to

open the keyboard.

3. Enter the correct license number or VIN code.
4. If no license plate or VIN code is available to identify the vehicle automatically, you can also choose the vehicle make, model, and year directly on the Vehicle Identification screen.

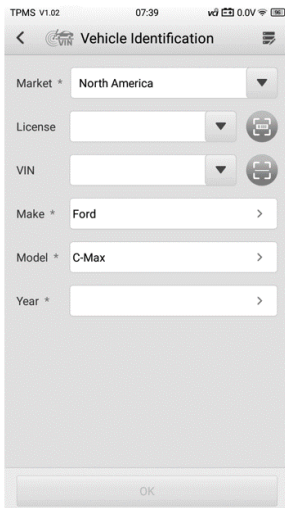

Figure 4-5 Vehicle Model Selection Screen

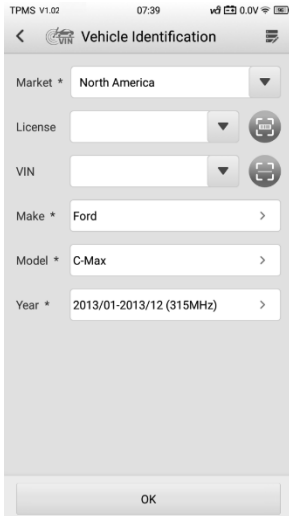

Figure 4-6 Vehicle Year Selection Screen

The following screen may display for vehicles using Indirect TPMS.

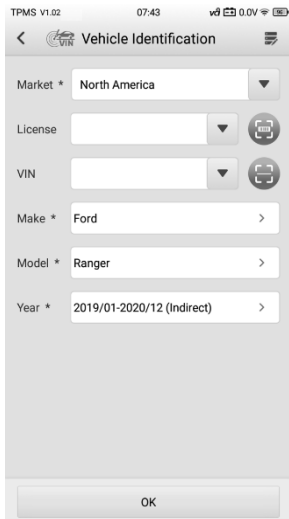

Figure 4-7 Indirect TPMS Selection Screen

For **Indirect TPMS** vehicle, only the **Relearn** function is supported. Not all vehicles provide Indirect TPMS mode. Tap the **Year** option bar to open a dropdown list of

model year. Find the model year that denotes with indirect TPMS system on the screen, for example, in the case of the above screen — 2019/01-2020/12 (indirect), a vehicle year model confirmation message displays, tap **OK** to confirm and display the Relearn Procedure, and follow the instructions to complete the operation.

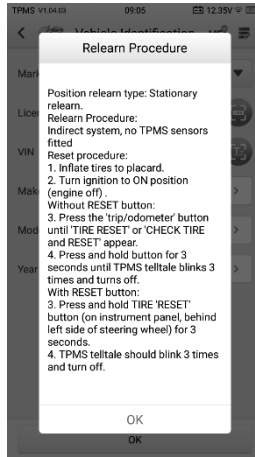

Figure 4-8 Relearn Procedure for Indirect TPMS

For vehicles using **Direct TPMS**, select the correct vehicle. The TPMS Service Menu will display.

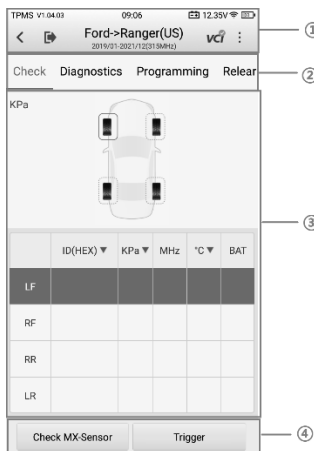





Figure 4-9 TPMS Service Menu

1. Top Toolbar Buttons — refer to [Table 4-2 Top Toolbar Buttons on Service Menu](#) for details.
2. Navigation Tab
3. Main Section
4. Function Buttons

4.3.4.1 Top Toolbar Buttons

Table 4-2 Top Toolbar Buttons on Service Menu

Button	Name	Description
	Back	Returns to the previous screen.
	Exit	Returns to the MaxiTPMS Job Menu.
	VCI	VCI is displayed at the upper-right corner of the screen when the VCI is not successfully connected to the tablet. After the MaxiVCI V200E is successfully connected to the tablet, the VCI icon is changed to VCI (with a check mark).
	More	Includes Data Logging and Report functions. <ul style="list-style-type: none"> ● Data Logging: records the communication data and ECU information of the test vehicle. See Data Logging for details. ● Report: displays the TPMS test report page. See TPMS Test Report for details.

4.3.4.2 Navigation Tab

The navigation tab at the top of the Main Section screen contains the following items:

1. Check Tab — triggers sensors and displays sensor data.
2. Diagnostics Tab — communicates with the test vehicle to perform diagnostics function, and displays diagnostics results including live data and DTCs.
3. Programming Tab — programs the MX-sensors and displays the new programmed sensor IDs and sensor PSNs (Product Serial Number).
4. Relearn Tab — displays the OE sensor information & Relearn procedure. Follow the instructions to perform relearn function.
5. Retrofit Tab — performs retrofit related functions of the selected vehicle model.

6. Wear Detection Tab — measures tire tread depth & brake disc wear and displays results graphically.
-

 **NOTE**

Not all vehicles support Diagnostics function. If the selected vehicle model does not support the Diagnostics function, this tab will not display.

4.3.4.3 Main Section

The data displayed includes sensor ID, tire pressure, sensor frequency, tire temperature, and battery status, along with vehicle-specific relearn procedures, the specifics of which depend on the operation.

4.3.4.4 Function Buttons

Specific function buttons will display depending on operation. These buttons or icons can be used to trigger the TPMS sensor, create sensor IDs, program MX-Sensors, and return to the previous screen or exit, etc.

4.4 TPMS Check

The **Check** function allows user to activate TPMS sensor to view sensor data — sensor ID, tire pressure, tire temperature, battery condition, and sensor position.

➤ **To check the sensors**

1. Follow the steps in [Vehicle Identification](#) to select the test vehicle.
 2. Hold the front side of the tablet close to the sensor mounted on the wheel. The trigger antenna is embedded in the tablet's top middle area.
 3. On the tablet, select the wheel you wish to trigger by either selecting the image of the wheel on the pictured vehicle or by selecting the corresponding wheel notation (LF, RF, RR, and LR). Tap the **Trigger** button to activate this sensor.
 4. Once the sensor is successfully triggered, the information of the sensor will display.
-

 **NOTE**

- If the battery level of a sensor is low, a red low battery icon  will display beside the wheel on the screen.
 - Once triggered, the wheel icons will display green or red indicating sensor status. Refer to [Table 4-3 Possible Results for Triggering](#) for details.
-

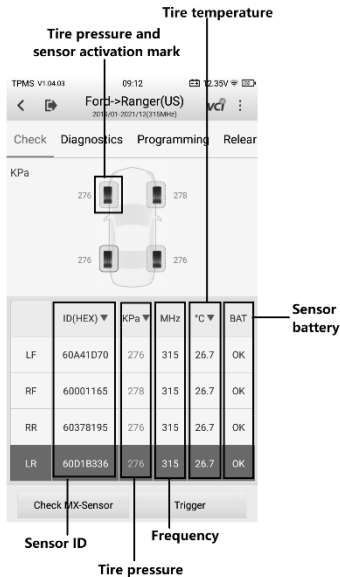





Figure 4-10 Check Screen

The sensor position, sensor ID, tire pressure, tire temperature, sensor frequency, and sensor battery information of the triggered sensor will display on the table.

Table 4-3 Possible Results for Triggering

Icon	Results	Description
 (Green)	Successful Sensor Read	TPMS sensor is successfully activated and decoded. The table displays the sensor information.
 (Green)	Successful Sensor Read & Low Battery	TPMS sensor is successfully activated and decoded, but the battery level of the sensor is low.

Icon	Results	Description
 <p>(Red)</p>	<p>Failed Sensor Read</p>	<p>If the search period expires and no sensor is activated or decoded, the sensor may be mounted incorrectly or does not function. The table displays “Failed.”</p> <p>If the tire pressure is not in the normal range, the icon will turn red.</p> <p>If a sensor with a duplicate ID has been read, the screen displays a message “Sensor ID duplicated.”</p> <p>Repeat the test procedure.</p>

4.5 TPMS Diagnostics

The **Diagnostics** function is used to check the status of the TPMS system. This function requires connection with the test vehicle.

4.5.1 Diagnosis Operations

Tap **Diagnostics**, and the tablet will automatically communicate with the vehicle.

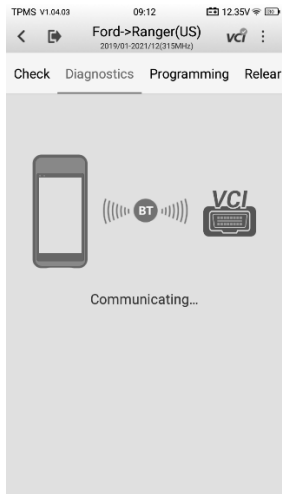

Figure 4-11 Communication Screen

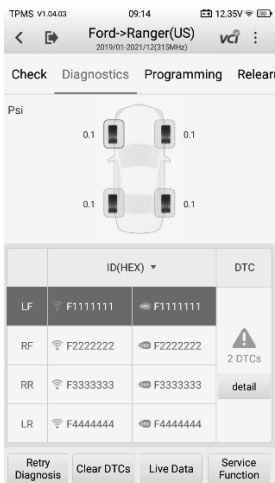

Figure 4-12 Diagnostics Screen

If the OBD function is supported by the test vehicle, the sensor ID saved in the TPMS ECU will be retrieved and displayed on the screen with an OBD icon adjacent to it.

If the sensor ID retrieved from sensor activation is the same as the ID saved in the ECU, the trigger mark () and OBD mark () will display green.

If the IDs are different, the marks will display red (and). In this case, the vehicle ECU cannot recognize the sensor installed on the vehicle.

If the OBD function is not supported by the test vehicle, the sensor ID saved in the TPMS ECU cannot be retrieved and only the sensor ID retrieved from sensor activation will display on the screen with a signal icon.

Details

If Diagnostic Trouble Codes (DTCs) are presented in the TPMS ECU, a yellow hazard icon will show up in the DTC column with the number of faults displayed below, and the **detail** button is available (see [Figure 4-12 Diagnostics Screen](#)).

Tap **detail** in the DTC column to view the detailed information of the DTCs.

In this screen, the detailed fault definition will display. Select one of the DTC and tap **Search**, and the tablet will automatically connect to the Internet and additional information will display.

If no DTCs present in the TPMS ECU, a green “No DTC” message will display on the DTC screen.

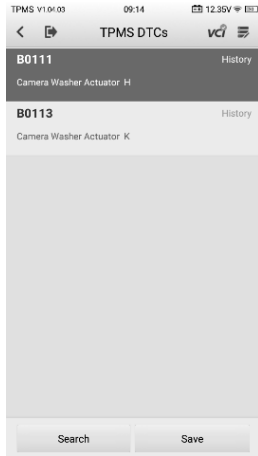

Figure 4-13 TPMS DTCs Screen

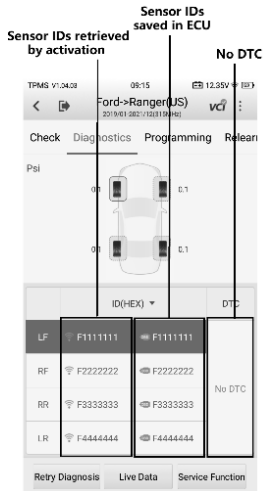

Figure 4-14 No DTC Screen

- **Retry Diagnosis**

Tap **Retry Diagnosis** to establish a communication with ECU again and retrieve sensor IDs and the DTCs present in the ECU.

- **Clear DTCs**

Tap **Clear DTCs** to clear the DTCs from the ECU. It is recommended that DTCs are read and needed repairs are performed before erasing codes.

- **Live Data**

Tap **Live Data** to view the data stream of the sensor information.

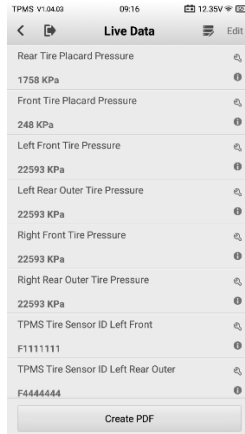



Figure 4-15 Live Data Screen

The Live Data screen displays all real-time data.

- ◆ Tap  on the right of screen to view details of the data stream.
- ◆ Tap  to open the dialogue box on the screen for additional information.

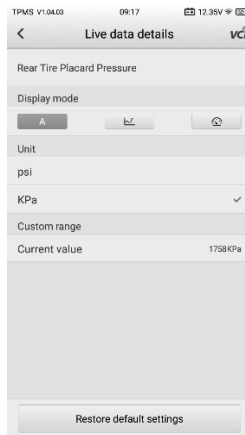

Figure 4-16 Details of Live Data Screen

There are three types of display modes available for data viewing, enabling you to view parameters in the mode that best suited to present data, and one Unit section, for switching the unit according to your preference.

➤ **To set the display mode**





1. Select the live data item of which parameters you want to view. Tap  to open the data stream details page.
2. Select one of the three display modes from the Display Mode section.
3. The corresponding display mode will show on the screen.

Table 4-4 Display Mode Table

Icon	Mode	Description
	Digital Mode	The default mode that displays the parameters in text.
	Waveform Mode	Displays the parameters in waveform.
	Analog Gauge Mode	Displays the parameters in an analog gauge mode.

4. On the **Live Data Details** screen, custom range is adjustable if under the waveform and analog gauge mode. Tap the **Restore Default Settings** button at the bottom of the screen to reset settings, or tap the **Return** icon on the top-left corner of the screen to go back to the previous screen, and the adjusted parameters will automatically display.

● **Service Function**

Tap the **Service Function** button to display a menu of available service functions.

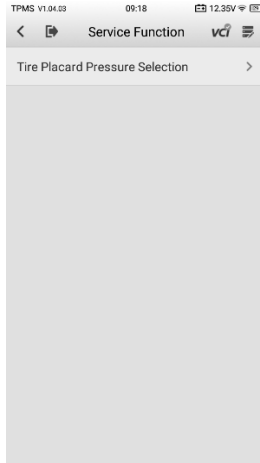

Figure 4-17 Service Function Screen

Tap the function displayed to initiate the desired service.

4.6 Sensor Programming

The **Programming** function allows users to program the sensor data to the MX-Sensor to replace existing sensors with low battery life and the ones that are no longer functioning.

This device offers four programming methods when programming MX-Sensor: **Copy by Activation**, **Copy by OBD**, **Copy by Input**, and **Auto Create**.

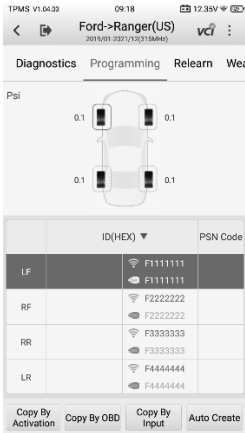

Figure 4-18 Programming Screen

4.6.1 Copy by Activation

Once the sensors mounted on the vehicle have been triggered and the sensor and tire information displayed on the tablet, you can apply **Copy by Activation** to program a new MX-Sensor (universal TPMS sensor provided by Autel).

Select a wheel location on the display screen and place an MX-Sensor in front of the tablet. Tap **Copy by Activation** to program a new MX-Sensor.

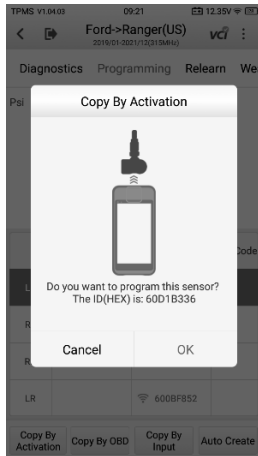

Figure 4-19 Copy by Activation Confirmation Screen

A window will display for your confirmation. Tap **OK** to program, or tap **Cancel** to quit the operation.

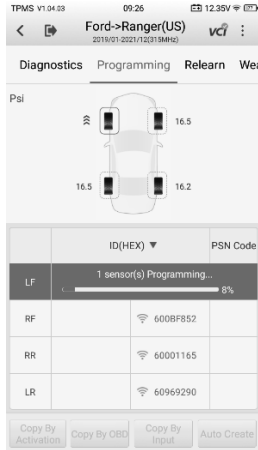

Figure 4-20 Copy by Activation Screen

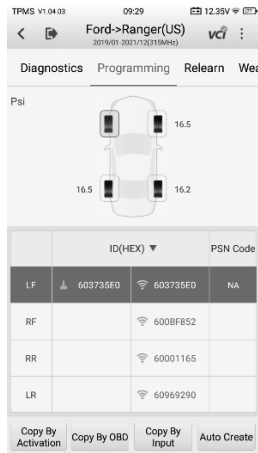

Figure 4-21 Copy by Activation Complete Screen

When the programming is complete, the programmed ID will display in the column to the right of the wheel designation. In the pictured example, the new ID is displayed to the right of the LF column.

By using **Copy by Activation**, the sensor ID that is retrieved from activated sensor is programmed to the new MX-Sensor.

Normally, since the IDs of the original sensor and the new MX-Sensor are the same and the ID is already recognized by the vehicle's ECU, there is no need to perform the **Relearn** function when the new programmed sensor has been attached to the same wheel.

4.6.2 Copy by OBD

If the IDs retrieved from sensor activation and those registered to the TPMS ECU are different, use **Copy by OBD** to program the IDs saved in the ECU to the new MX-Sensor.

By using this function, the tablet will program the sensor IDs retrieved from the ECU of the test vehicle to the new MX-Sensors.

After the sensor ID is retrieved by performing diagnostics function. Select a wheel location on the display and place an MX-Sensor in front of the tablet. Tap **Copy by OBD** to program the new MX-Sensor.

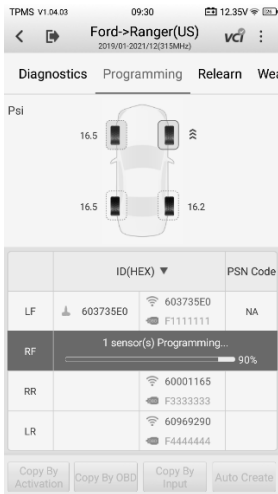

Figure 4-22 Copy by OBD Screen

When the programming is complete, the programmed ID will display in the column to the left of the wheel designation. In the pictured example, the new ID is displayed to the right of the LF column.

By using **Copy by OBD**, the sensor ID that is retrieved from TPMS ECU is programmed to the new MX-Sensor.

Normally, there is no need to perform the **Relearn** function to write the ID into the ECU when the new programmed sensor has been put in the same position.

The **Copy by OBD** programming method, if available, is recommended to program new MX-Sensors as there is no need for Relearn.

4.6.3 Copy by Input

The **Copy by Input** allows users to manually enter the Sensor ID and program a new MX-Sensor with the ID of an original TPMS sensor.

Select a wheel location on the display and place an MX-Sensor in front of the tablet and then tap **Copy by Input** to program the new MX-Sensor.

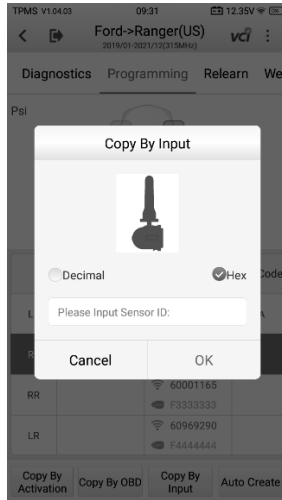

Figure 4-23 Copy by Input Screen

Tap **Copy by Input**. When the input box displays, enter the ID of the original sensor. Tap inside the input box to display a soft keyboard. Once displayed, input the ID.

NOTE

Sensors either have a hexadecimal format or a decimal format. A warning message will display if too many characters are entered.

The **Copy by Input** programming method uses the ID of the original sensor that is already stored within the TPMS ECU and therefore normally does not require the sensor be relearned if the new programmed sensor has been put in the same position.

4.6.4 Auto Create

The **Auto Create** function is used to automatically create new sensor IDs to program new MX-Sensors. Make sure the sensors to be auto created are placed within 0.33 feet (10 cm) of the tablet, and avoid possible programming errors by putting the other sensors at least 3.94 feet (1.2 m) away from the tablet. Up to 20 MX-Sensors can be programmed at the same time.

Select the vehicle model. Select a wheel location on the display and place MX-Sensors in front of the tablet. Tap **Auto Create** to program new MX-Sensors.

New IDs will be created for the MX-Sensors. These new IDs differ from the IDs stored in the TPMS ECU. Therefore, the sensors will have to be relearned to the TPMS ECU.

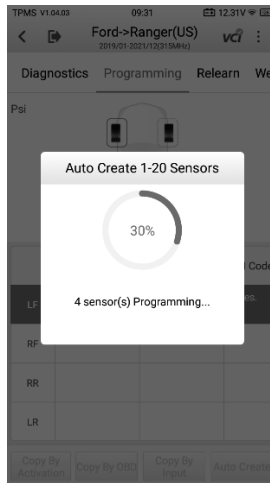

Figure 4-24 Auto Create Screen

NOTE

Maximum of 20 MX-Sensors can be programmed at once and without unboxing. It is suggested to place the tablet in front of the longer side of the packaging box for best programming result. See [Figure 4-25 Auto Create Diagram](#) below for more information.

➤ **To program 20 MX-Sensors without unboxing**

1. Tap **Auto Create**.
2. The tablet will create and display the new IDs.
3. Place the new MX-Sensors in front of the MaxiTPMS tablet.
4. Tap **OK** to program the sensors with the new IDs.

NOTE

Since new IDs have been created, a relearn process is essential.



Figure 4-25 Auto Create Diagram

4.7 TPMS Relearn

This function is used to transfer new sensor IDs into the vehicle ECU for sensor recognition. Step-by-step relearn instructions are provided for all supported vehicles. Relearn is needed when the new sensor IDs are different from the original sensor IDs stored within TPMS ECU.

Three major methods are available for relearn process. According to the actual situation, perform the most suitable TPMS relearn method.

- OBD Relearn
- Automatic Relearn
- Stationary Relearn

4.7.1 OBD Relearn

4.7.1.1 OBD Relearn

The OBD Relearn function allows the MaxiTPMS tablet to directly write the TPMS sensor IDs to the TPMS module.

NOTE

A few vehicles do not support OBD Relearn for original design. If the function is supported by the selected vehicle, the **OBD Relearn** button will display on the bottom of the screen. Regarding some vehicles, if OBD Relearn is not provided by the tool, then the **OBD Relearn** button will not display.

To perform the Relearn function, activate all four sensors.



Figure 4-26 OBD Relearn Screen 1

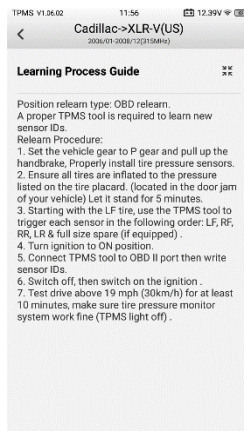

Figure 4-27 OBD Relearn Screen 2

4.7.1.2 OBD-Assisted Relearn

The MaxiTPMS tablet can also perform an OBD-Assisted Relearn session directly. Some vehicles relearn procedure require that a tool be always connected to the vehicle while another tool be used to trigger the sensor at the wheel.

Since the tablet wirelessly communicates with vehicles, it can be used to trigger wheel-mounted sensors while still being connected with the vehicle eliminating the need for a second tool. The sensor IDs are then relearned to the vehicle.

4.7.2 Automatic Relearn

For some vehicles, the Relearn function can be completed by driving. Refer to the on-screen Relearn Procedure for the exact details of the process.

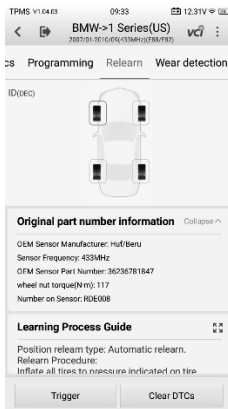

Figure 4-28 Automatic Relearn Screen 1

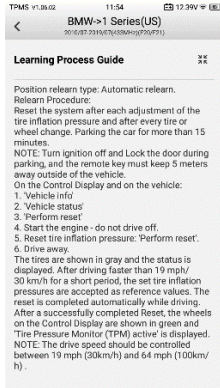

Figure 4-29 Automatic Relearn Screen 2

4.7.3 Stationary Relearn

Stationary Relearn requires the vehicle be placed in the “Relearn Mode”.

Tap **Relearn** to access the relearn menu.

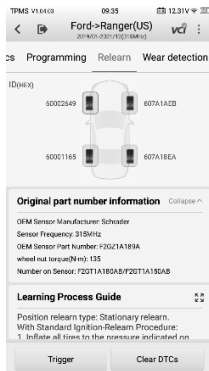

Figure 4-30 Stationary Relearn Screen 1

Then follow the **Relearn Procedure** to perform Stationary Relearn.

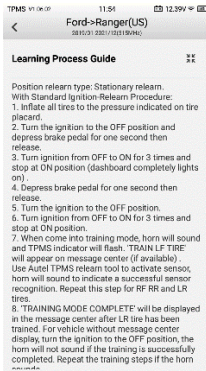

Figure 4-31 Stationary Relearn Screen 2

4.8 Retrofit

Refer to [TPMS Retrofit](#) for details.

4.9 Wear Detection

The wear detection is for detecting wear status of tire tread and/or brake disc, which contains four types of checks, including **All Tread Check**, **Single Check**, **Quick Check**, and **Brake Disc Check** operations, and allows for adding tire tread depth & brake disc wear measurement data into TPMS test report for comprehensive analysis.

The wear detection function is designed to be performed by using the TBE200 device (hereafter referred to as TBE device). Once paired, you can initiate check sessions through the TBE device, which will take full control to perform measurements with the data detected automatically transferred to the paired tablet.

There are two ways of switching to a different check mode via the TBE device:

- A. All Tread Check/Single Check — on the TBE device, tap the **Tire Tread** icon on the Main Job screen, a prompt will display, notifying the current check mode. Tap **Cancel** to stay in the current mode, or tap **Switch** to perform the other check mode. You can also switch between All tread check and Single check in the **Check Settings**.
- B. Quick Check/Brake Disc Check — on the TBE device, simply tap the **Quick Check** or **Brake Disc** icon on the Main Job screen to execute the checking procedure.



Figure 4-32 TBE Manager Screen

Prior to measuring, also make sure to adjust settings on the Wear Detection screen via the tablet or through Check Settings on the TBE device.

4.9.1 Function Operations

To use this function, the TBE device must be connected to the tablet. Follow the instructions in the Note section to perform the wear detection function.

NOTE

If a TBE device is not available for connection, tap the **Manual Input** button at the bottom of the Wear Detection screen to manually input the tire tread & brake disc data measured by a third-party device.

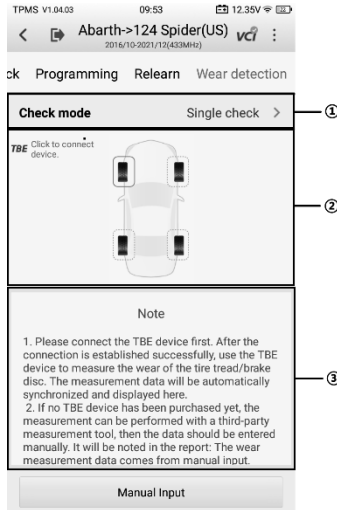

Figure 4-33 Wear Detection Screen

1. Check Settings
2. Main Section — shows the vehicle TBE connection icon.
3. Note Section — displays instructions of TBE device pairing.

4.9.1.1 Check Settings

Check settings contains a series of settings that allow you to perform check operations as you desired, such as the check mode, tire type, limit settings, and data unit.

- Tread Check Mode — four modes are available, including All tread check, Quick check, Single check, and Brake disc check.
- Tire Type — displays three tire types, including Summer, Winter, and All-season tires.
- Tire Tread or Brake Disc Wear Limit Settings — shows the default settings of tire tread & brake disc wear parameters.
- Data Unit — adjusts the measurement unit.

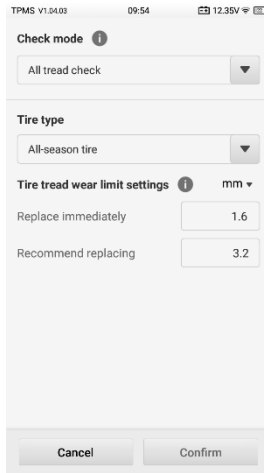

Figure 4-34 Check Settings Screen

4.9.1.2 Main Section

The main section in the center of the screen displays the TBE icon as well as the vehicle model tested graphically.

4.9.1.3 Note Section

The note section provides instructions on how to perform the wear detection function by using a compatible TBE device or a third-party tool.

4.9.2 Check Mode

There are four check modes provided. Below are the detailed descriptions.

4.9.2.1 All Tread Check

The all tread check function assists to examine your tire wear in three separate areas: outer, center, and inner for a comprehensive analysis.

4.9.2.2 Single Check

The single check function allows for measuring tread depth on each tire of the test vehicle. Unlike all tread check, single check only measures one location on each tire for results.

4.9.2.3 Quick Check

The function combines measuring tread depth together with brake disc wear to make it

easy for technicians.

4.9.2.4 Brake Disc Check

The brake disc check function checks for brake disc wear and provides wear analysis. Similar to single check that targets tire depth, this check mode focus on brake disc measurements only.

➤ **To pair the tablet with the TBE device via Wi-Fi direct mode**

1. On the TBE device, go to **Settings > Network connection > Wi-Fi direct**, and swipe the Wi-Fi direct toggle to turn it on.
2. On the tablet, go to **Settings > TBE Manager** to open the **TBE Manager** screen. Or, open the TPMS application, on the Wear Detection screen, tap the TBE icon to access the TBE Manager screen for connection.
3. Tap **Scan** at the upper-right corner of the tablet's screen. The tablet will automatically search for available TBE devices.
4. The name of the device will appear. Select the device for connection, and tap the device name to establish a communication link.
5. After the connection is established, open the Tire Tread application on the TBE device and start measuring.

 **NOTE**

A prompt will display when open the Tire Tread function, notifying the current check mode and if want to switch to another one. You can also switch between all tread check and single check in the Check Settings via the TBE device.

6. The measurement data on the TBE device will automatically transfer to and display on the paired tablet.
7. To switch to brake disc or quick check, take quick check for example, simply open the Quick Check application on the TBE device to perform measurements.

The **Data Query** function on the TBE device stores data of the previous measurement session, which will display on the tablet screen automatically. Once a new measuring session starts, the previous data will naturally be replaced by the newly tested one.

 **NOTE**

Once paired, tire & brake disc wear condition, DOT, and other tire-related information will be automatically transferred from TBE device to the paired tablet.

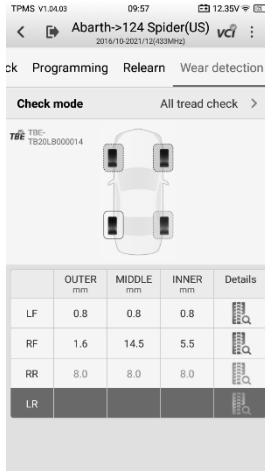

Figure 4-35 All Tread Check Screen

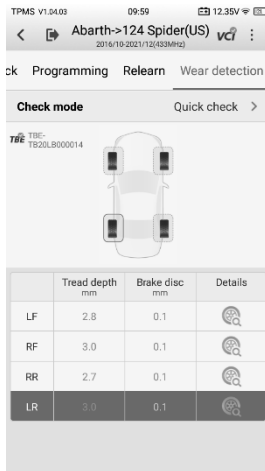

Figure 4-36 Quick Check Screen

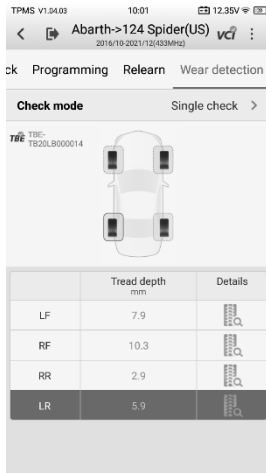

Figure 4-37 Single Check Screen

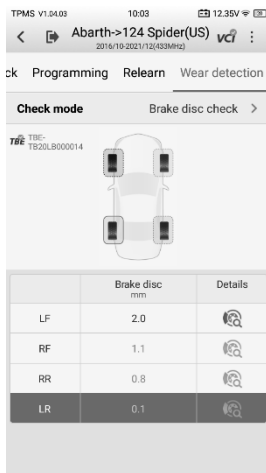

Figure 4-38 Brake Disc Check Screen

4.9.3 Details

The **Details** screen shows a wide variety of tire and brake disc information. After measurements are shown on the Wear detection screen, select a wheel location, tap the corresponding tire or brake disc icon under the Details column to enter the next screen. Different check mode varies in terms of displaying sections. Below are the main sections featured on the Details screen:

- 1) Graphic measurements — shows the measurements data graphically with various colors indicating different tire and/or brake disc wear conditions,
 - All Tread Check & Single Check — presents only the tire tread wear conditions graphically while the all tread check mode displays measurements of the inner, center, and outer areas of the tire, while for the single check mode.
 - Quick Check — displays both the tire tread & brake disc wear conditions graphically.
 - Brake Disc Check — displays only the brake disc wear.
- 2) Braking distance — displays the stopping distance for the test vehicle graphically with the corresponding tire tread depth. The braking distance varies with the type of tires changed accordingly. This section also followed by wear analysis and maintenance suggestions.
 - Quick Check — specially contains analysis of brake disc wear.
 - Brake Disc Check — braking distance is available for all check modes, except for Brake disc mode.

The following three tire-related sections are provided in all the check modes except for the brake disc one:

- 3) Tire Condition — presents with nine tire status, including normal, worn, and bulge.
- 4) Tire DOT — scans the tire DOT serial number located on the sidewall to acquire basic characteristics such as tire age, recall status, and warning. Refer to [Tire DOT](#) for additional information.
- 5) Tire Specification — presents a series of options regarding tire characteristics, including Make, Tire Width, and Type Code.

NOTE

On the Details screen, the measurements are shown graphically and changes colors with the Tire Condition manually selected to provide a more comprehensive analysis.

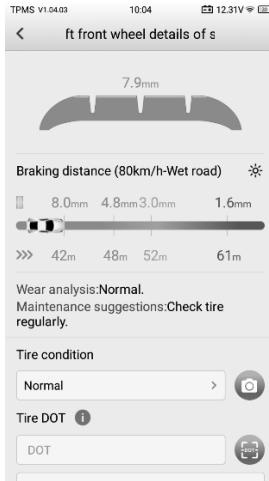



Figure 4-39 Details Screen

On the Wear Detection screen, measurements and the tire/brake disc icon will display green, yellow, or red indicating wear status. Refer to [Table 4-2 Top Toolbar Buttons on Service Menu](#) for details.











Tap the  icon on the top-right corner of the screen to access the TPMS test report generated.

NOTE

The TPMS test report supports third-party measurements as well. Refer to [TPMS Test Report](#) for more details.

Tire and brake disc icons are highlighted with colors that described in the table below.

Table 4-2 Possible Results for Measurements

Tire Tread	Quick Check	Brake Disc Check	Results	Description
 (Gray)			Untested	The tire/brake disc is untested.
 (Green)			Good	The tire/brake disc is in good condition.
 (Yellow)			A replacement is recommended.	It is suggested to replace the tire/brake disc.
 (Red)			Immediate replacement is recommended.	It is suggested to replace the tire/brake disc immediately.

5 TPMS Retrofit

Retrofit is needed to be performed if your vehicle is not installed with TPMS system by default. Tap on the **TPMS Retrofit** application button on the MaxiTPMS Job Menu to access the function.

5.1 Retrofit

This function is used to install TPMS system in vehicles. Tapping the **TPMS Retrofit** application icon opens the Vehicle Identification screen. See [Vehicle Identification](#) for additional information.

Prior to use the function, ensure the ignition light is in **ON** position with the MaxiVCI V200E device successfully connected to the vehicle and the tablet.

➤ To perform retrofit function

1. Tap the **TPMS Retrofit** application button from the MaxiTPMS Job Menu.
2. Select the manufacturer button of the test vehicle, followed by the vehicle model and year.
3. Tap **OK** at the bottom of the screen to confirm information of the tested vehicle. The Retrofit screen opens.
4. Simply follow the operation instructions displayed on the screen, which will guide you to choose the corresponding buttons during each procedure, including the Back-up, Retrofit, and Restore buttons.

The Retrofit function screen has the same lay out with that of the TPMS screen. After the retrofit function is finished, tap on the other tabs to perform optional functions.

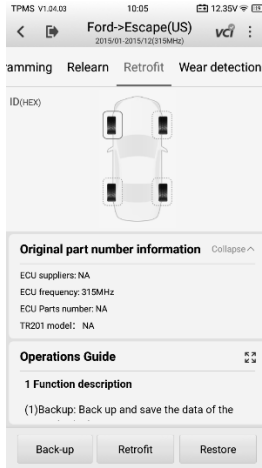

Figure 5-1 TPMS Retrofit Screen

NOTE

Accesses the TPMS retrofit function either by tapping **TPMS** on the MaxiTPMS Job Menu or directly tapping **TPMS Retrofit**. The **TPMS Retrofit** lists vehicles available for retrofit only. The TPMS application covers all vehicles, with which available for retrofit will display retrofit tab on the screen.

6 Battery Test

The BT506 is a battery and electrical system analysis tool that uses Adaptive Conductance, an advanced battery analysis method to produce a more accurate examination of the battery's cold cranking ability and reserve capacity, vital to determining a battery's true health. The BT506 enables technicians to view the health status of the vehicle's battery and electrical system. Together with the BT506, this application can complete battery & starting and charging system tests and display the test results.

6.1 MaxiBAS BT506 Battery Tester

6.1.1 Function Description

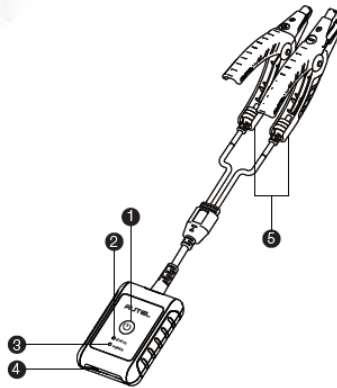

Figure 6-1 *MaxiBAS BT506 Battery Tester*

1. Power Button
2. Status LED
3. Power LED
4. USB Port
5. Battery Clamp Cable

Table 6-1 LED Description

LED	Color	Description
Status LED	Flashing Green	The tester is communicating via USB cable.
	Flashing Blue	The tester is communicating via Bluetooth.
	Flashing Red	Battery clamps are connected to the wrong battery terminals.
Power LED	Solid Green	The tester is powered on and the battery is sufficiently charged.
	Flashing Green	The tester is charging. (Turns solid green when battery is fully charged.)
	Solid Red	The device is in boot mode.
	Flashing Red	The battery level is low. Please charge.

6.1.2 Power Sources

The BT506 battery tester can receive power from the following sources:

- Internal Battery Pack
- AC/DC Power Supply

! IMPORTANT

Do not charge the tester when the temperature is below 0 °C (32 °F) or above 45 °C (113 °F).

6.1.2.1 Internal Battery Pack

The BT506 battery tester can be powered with the internal rechargeable battery.

6.1.2.2 AC/DC Power Supply — Using Power Adapter

The BT506 battery tester can be powered from an electrical outlet using the AC/DC power adapter. The AC/DC power supply also charges the internal battery pack.

6.1.3 Technical Specifications

Table 6-2 Technical specifications

Item	Description
Connectivity	<ul style="list-style-type: none">• USB 2.0, Type C• Bluetooth 4.2
Input Voltage	5 V DC
Working Current	< 150 mA at 12 V DC
Internal Battery	3.7 V/800 mAh lithium-ion polymer battery
CCA Range	100 to 2000 A
Voltage Range	6 to 36 V
Working Temp.	-10 °C to 50 °C (14 °F to 122 °F)
Storage Temp.	-20 °C to 60 °C (-4 °F to 140 °F)
Dimension (L x W x H)	107 mm (4.21") x 75 mm (2.95") x 26 mm (1.02") (clamp cable not included)
Weight	320 g (0.7 lb.)

6.2 Test Preparation

6.2.1 Inspect the Battery

Before starting a test, inspect the battery for:

- Cracking, buckling or leaking (If you see any of these defects, replace the battery.)
- Corroded, loose or damaged cables and connections (Repair or replace as needed.)
- Corrosion on the battery terminals, and dirt or acid on the case top (Clean the case and terminals using a wire brush and a mixture of water and baking soda.)

6.2.2 Connect the Battery Tester

➤ **To connect BT506 with the MaxiTPMS tablet**

1. Turn on both BT506 and the MaxiTPMS tablet.
2. Tap the **Settings** application button on the MaxiTPMS Job Menu, and select **VCI Manager**.

3. Tap **Scan** at the upper-right corner of the tablet's screen.
4. The device name may display as "Maxi" suffixed with a serial number. Select the appropriate device for pairing.
5. When paired successfully, the connection status displays the device name with the message "Paired."
6. Once paired, the VCI button on the upper-right corner of the screen will display a green check and the Connection LED on the BT506 illuminates blue. This signifies that the tablet is connected to the BT506, and it is ready to for use.

➤ **To connect to a battery**

1. Press and hold the **Power/Lock** button to turn on the BT506 tester.
2. Connect the red clamp to the positive (+) terminal and the black clamp to the negative (-) terminal of the battery.

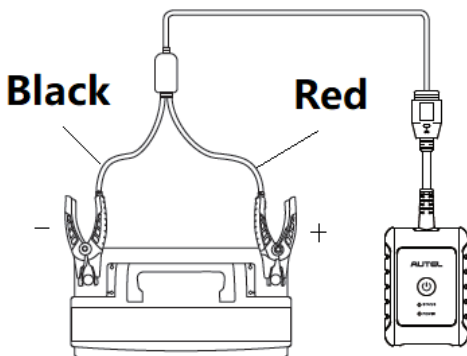

Figure 6-2 Connecting to a Battery

3. The black clamp is installed with an infrared sensor near the clamp mouth that tests the battery temperature. The battery temperature will appear on the Battery Test Result screen or on the Battery Test Report.

6.3 In-vehicle Test

In-vehicle Test is used for testing batteries that are installed in a vehicle. An in-vehicle test includes battery test, starter test, and generator test. These tests help determine the health status of the battery, the starter, and the generator, respectively.

❗ IMPORTANT

1. Before using the diagnostic functions, download the desired vehicle software on the Update application.
2. A Disclaimer page will appear when accessing any function on the Battery Test screen for the first time. Please read the end user agreement and tap **Accept** to continue. If you tap **Decline**, you will not be able to use the features properly.

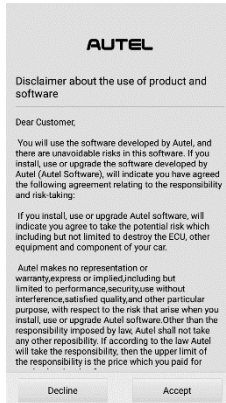

Figure 6-3 Disclaimer Screen

6.3.1 Battery Test

- **To perform the in-vehicle battery test**
 1. Tap the **Battery Test** application button on the MaxiTPMS Job Menu. The Battery Test screen displays.
 2. Select **In-vehicle Test**.

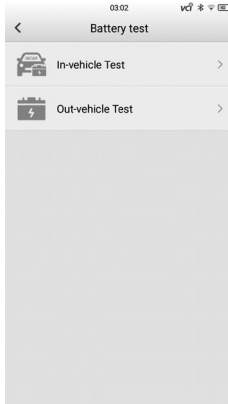

Figure 6-4 Battery Test Screen

3. Perform OBD connection by following the on-screen instructions.

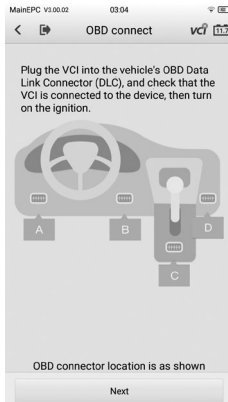

Figure 6-5 OBD Connect Screen

4. Confirm the vehicle information. The vehicle information will be automatically populated when vehicle communication is established. A Battery Information tab will pop up from the bottom of the screen.

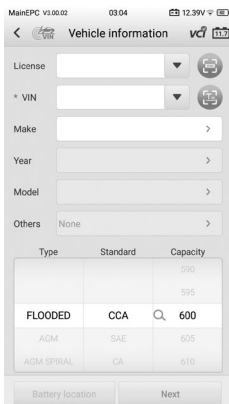





Figure 6-6 Vehicle Information Screen

NOTE

In the Settings application, the VIN option allows you to change the requirement for entering the VIN information. If the setting is enabled, supplying the VIN is no longer mandatory.

Table 6-3 Upper Toolbar Buttons

Button	Name	Description
	Back	Returns to the previous screen.
	ESC	Returns to the Home screen.
	Battery Connection	Displays the battery connection status. The number on the icon indicates the real-time voltage of the tested battery.

5. Tap **Next** and access to the Battery screen. Perform required operations before the battery test based on the on-screen instructions. And tap the **Start testing** button.
6. Wait for the battery test to complete and view the test results and suggestions.

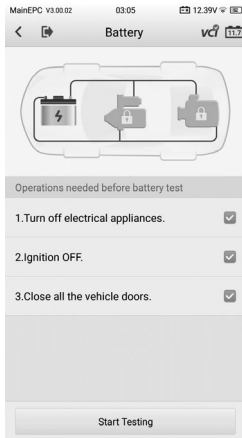

Figure 6-7 Battery Screen

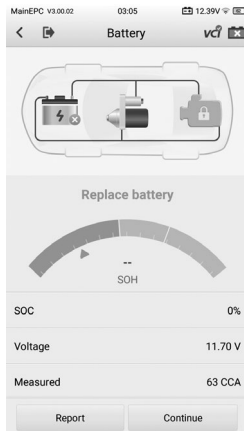

Figure 6-8 Battery Result Screen

6.3.2 Starter Test

➤ **To perform the starter test**

1. Tap **Continue**. Perform required operations before the battery test based on the on-screen instructions. And tap the **Start testing** button.
2. Turn the vehicle ignition to ON when the following screen displays.



Figure 6-9 Starter Screen 1



Figure 6-10 Starter Screen 2

3. Wait for the test to complete and view the test results.

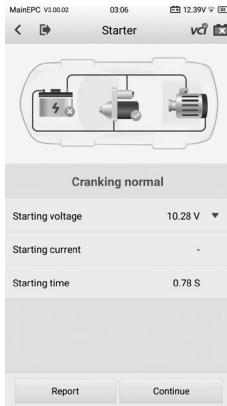

Figure 6-11 Starter Test Result Screen

Table 6-4 Starter Test Results

Result	Description
Cranking Normal	The starter is good.
Current Too Low	Low momentary discharge capacity.
Voltage Too Low	Low battery storage capacity.
Not Started	The starter is not detected for starting.

6.3.3 Generator Test

➤ **To perform the generator test**

1. Tap **Continue**. Perform required operations based on the on-screen instructions.
2. Tap **Continue** and view the test results.

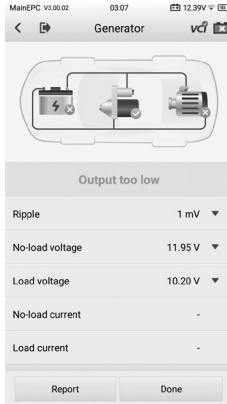

Figure 6-12 Generator Test Result Screen

Table 6-5 Generator Test Results

Result	Description
Charging Normal	The generator is good.
Output Too Low	<ul style="list-style-type: none"> ● The belt linking the starter and the generator is loose; ● The cable linking the starter and battery is loose or corroded.
Output Too High	<ul style="list-style-type: none"> ● The generator is not properly connected to the ground; ● The voltage adjuster is broken and needs replacement.
Ripple Too Large	The commutation diode is broken and needs repair or replacement.
No Output	<ul style="list-style-type: none"> ● The cable is loose; ● Some vehicles with power management systems do not provide a path for charging due to the sufficient load capacity of the battery; ● The generator or the voltage adjuster is broken and needs replacement.

6.4 Out-vehicle Test

Out-vehicle test is used to test the condition of batteries that are not connected to a vehicle. This function aims to check the health status of the battery only. The battery types and standards able to be tested are as follows.

Types: FLOODED, AGM, AGM SPIRAL, EFB, and GEL

Standards: CCA, SAE, CA, EN, IEC, DIN, JIS and MCA

6.4.1 Battery Test

- **To perform the out-vehicle battery test**
 1. Tap the **Battery Test** application button on the MaxiTPMS Job Menu. The Battery Test screen displays.
 2. Select **Out-vehicle Test**.
 3. Check the battery information and tap **Start testing**.

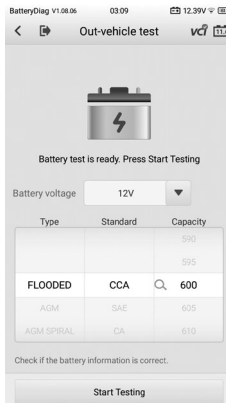

Figure 6-13 Sample Out-vehicle Test Screen

4. Wait for the battery test to complete and view the test results.

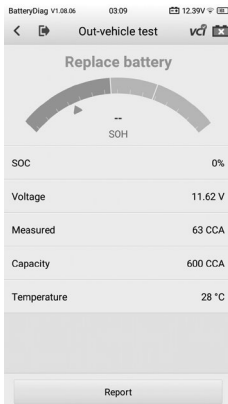

Figure 6-14 Out-vehicle Test Result Screen

Table 6-6 Out-vehicle Test Results

Result	Description
Good Battery	Battery meets required standards.
Good & Recharge	Battery is good, but low on charge. Fully charge the battery. Check for causes of low charge.
Charge & Retest	Retest after charging.
Replace Battery	Battery fails to meet industry-accepted standards.
Bad Cell	Battery fails to meet industry-accepted standards.

7 OE Entry

7.1 TPMS by OEM Part No.

If the sensor's OEM part No. is known, this function is an efficient method to activate all known TPMS sensors and program specifically the MX-Sensors.

Selecting the OEM part No. opens the functional page for performing sensor activation and programming. Tap the **Support** tab, then choose the vehicle model of your preference, and then tap **Enter Vehicle** button at the bottom of the screen to access the corresponding TPMS Service Menu and perform TPMS service function.

7.1.1 Application Scenarios

The following are two typical scenarios in which this method is ideal.

7.1.1.1 *In the workshop*

If the mounted sensor is faulty and the part number is known to the technician, the technician can use this method to check the original sensor, and then write the information that was retrieved into a new MX-Sensor via Programming. The newly programmed MX-Sensor is ready to replace the original sensor and be installed on the vehicle.

7.1.1.2 *In the tire shop*

If a customer needs to replace one or more tires and sensors, or purchase a large number of sensors for one vehicle model and the OEM part No. of this model is known, this function can be used to program up to 20 sensors at the same time.

7.1.2 Function Operations

1. Tap **OE Entry** on the MaxiTPMS Job Menu. A list of sensor OEM sensor manufacturers will display. Swipe up or down the screen to find the manufacturer of the sensor on the test vehicle, and tap the manufacturer name to enter the next screen and then select the specific OEM sensor No.

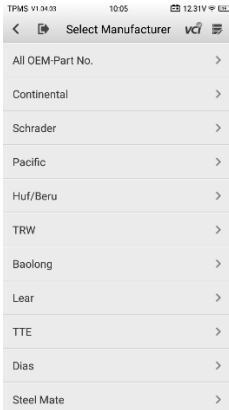

Figure 7-1 OEM Sensor Manufacturer Screen

2. Or, tap All OEM-Part No., to the search box on the top of the screen to enter the OEM part No. A soft keyboard will display as below. Enter the OEM Part No. in the search box to complete the operation. Tap **?123** to change the keys to numbers; tap **ABC** to change the keys to letters.

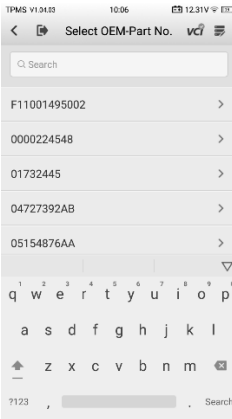

Figure 7-2 OEM Part No. Search Screen

3. When a specific OEM part No. is selected, the screen will display as pictured below.

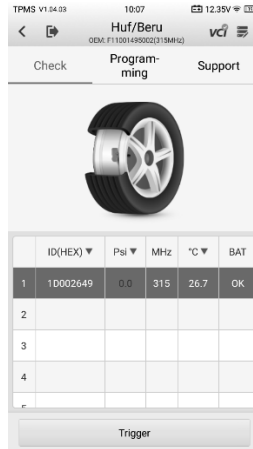

Figure 7-3 OEM Part No. Service Menu

NOTE

Only sensor Check and Programming functions are available. The Diagnostics and Relearn functions can only be accessed by selecting a vehicle on the TPMS service menu.

7.1.2.1 Check

The **Check** tab is the default selection on this menu. Tap **Trigger** on the bottom-left of the screen to activate the original sensors and retrieve the sensor information. The original sensor ID, tire pressure, tire temperature, sensor battery, and sensor frequency will populate the displayed table.

NOTE

You can change the unit on the table header according to your preference.

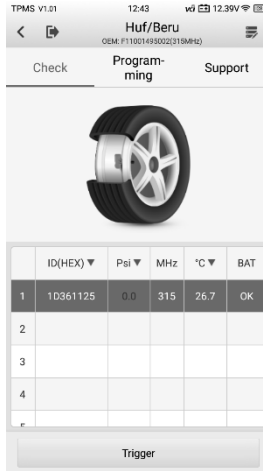

Figure 7-4 Check Screen via OEM Part No.

7.1.2.2 Programming

The **Programming** function is used to program the sensor data to the MX-Sensor and replace the faulty sensor.

There are three options available when programming MX-Sensor using the OEM Part No. function: **Copy by Activation**, **Copy by Input**, and **Auto Create**. See [Sensor Programming](#).

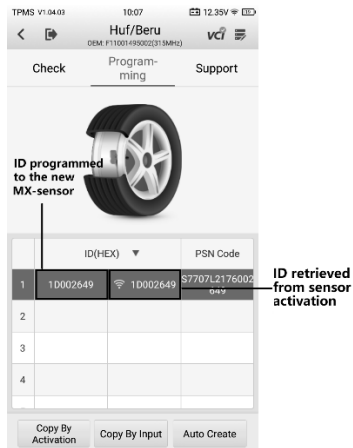

Figure 7-5 Programming Screen via OEM Part No.

The **PSN Code** (Part Serial Number), which is printed on the MX-Sensor, acts as a reference to identify the corresponding sensor ID. This can be especially useful when programming multiple MX-Sensors.

7.1.2.3 Support

Support will display the correct vehicle types for the selected OEM part No.

To conduct additional procedures such as Diagnostics and Relearn, select the correct test vehicle model and then tap **Enter Vehicle** at the bottom of the screen. See [TPMS Diagnostics](#) and [TPMS Relearn](#) for more details about the comprehensive TPMS functions menu.

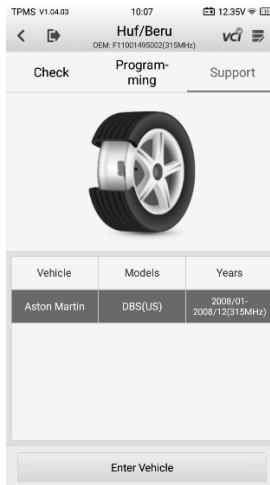

Figure 7-6 Support Screen

8 Diagnostics

The Diagnostics application, via the MaxiVCI V200E, can access the electronic control module (ECM) for various vehicle control systems, such as engine, transmission, antilock brake system (ABS), airbag system (SRS), view live data parameters. The all-system diagnostics function is available with update purchase. See [Activate Pro Function](#) for details.

8.1 Getting Started

Ensure a communication link is established between the test vehicle and the tablet via the MaxiVCI V200E. Refer to [Establishing Vehicle Communication](#) for details.

8.1.1 Vehicle Menu Layout

When the tablet is properly connected to the vehicle, the platform is ready to start vehicle diagnosis. Tap on the **Diagnostics** application button on the MaxiTPMS Job Menu to access the Vehicle Menu.



Figure 8-1 Vehicle Menu Screen

1. Top Toolbar Buttons — see [Table 4-1 Top Toolbar Buttons on Vehicle Menu](#) for details.
2. Manufacturer Buttons — To begin, select the manufacturer button of the test vehicle, followed by the vehicle model and year.

8.2 Vehicle Identification

The MaxiTPMS diagnostic system supports four methods of Vehicle Identification.

1. Auto VIN Scan
2. Manual VIN Input
3. Automatic Selection
4. Manual Selection

8.2.1 Auto VIN Scan

The MaxiTPMS diagnostic system features the VIN-based Auto VIN Scan function to identify vehicles and scan all diagnosable ECUs and run diagnostics on the selected system. This function is compatible with vehicles manufactured from 1996.

➤ To perform Auto VIN Scan

1. Tap the **Diagnostics** application button on the MaxiTPMS Job Menu. The Vehicle Menu displays.
2. Tap the **VIN Scan** button on the top toolbar to open the dropdown list.



Figure 8-2 Auto VIN Screen

3. Select **Auto VIN**. Once the test vehicle is identified, the screen will display the VIN. Tap **OK** at the bottom-right to confirm the VIN. If the VIN does not match with the test vehicle's VIN, enter VIN manually or tap **Read** to acquire VIN again.



Figure 8-3 VIN Information Screen

4. Review the information. Tap **Yes** to confirm the vehicle profile or tap **No** to cancel.

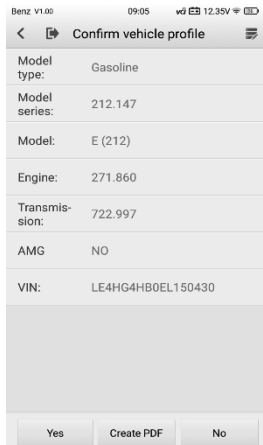

Figure 8-4 Vehicle Profile Screen

5. The tool establishes communication with the vehicle and opens the Main menu. Tap **Diagnosis** and select **Auto Scan** to scan all the test vehicle available systems or tap **Control Unit** to access a specific system to diagnose.

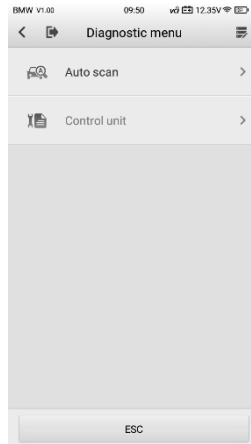

Figure 8-5 Vehicle Profile Screen

8.2.2 Manual VIN Input

For vehicles does not support the Auto VIN Scan function, manually enter the vehicle VIN.

➤ To perform Manual VIN Input

1. Tap the **Diagnostics** application button on the MaxiTPMS Job Menu. The Vehicle Menu displays.
2. Tap the **VIN Scan** button on the top toolbar to open the dropdown list.
3. Select **Input VIN**.
4. Tap the input box and enter the correct VIN.

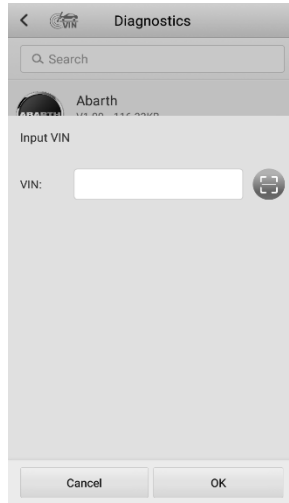

Figure 8-6 Manual VIN Input

5. Tap **OK**. Once the vehicle is identified, the Vehicle Diagnostics screen displays.
6. Tap **Cancel** to exit Input VIN.

8.2.3 Automatic Selection

The Auto Selection can be selected after selecting the test vehicle manufacturer.

➤ **To perform Automatic Selection**

1. Tap the **Diagnostics** application button on the MaxiTPMS Job Menu. The Vehicle Menu displays.
2. Tap the manufacturer menu of the test vehicle and then select **Automatic Selection**.
3. Once the vehicle information is confirmed, the VIN information is automatically acquired. Follow the on-screen instructions to display the Vehicle Diagnostics screen.

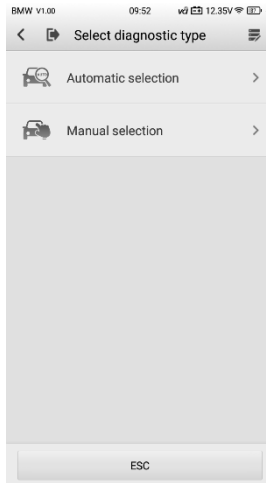

Figure 8-7 Automatic Selection Screen

8.2.4 Manual Selection

When the vehicle's VIN is not automatically retrievable through the vehicle's ECU, or the specific VIN is unknown, the vehicle can be manually selected.

This mode of vehicle identification is menu-driven. Repeat the first two steps from the automatic selection operation and tap **Manual Selection**. Through a series of on-screen prompts and selections the test vehicle is chosen. Confirm vehicle profile before starting diagnostics.

8.3 Navigation

Navigating the Diagnostics interface and selecting tests are discussed in this section.

8.3.1 Diagnostics Screen Layout

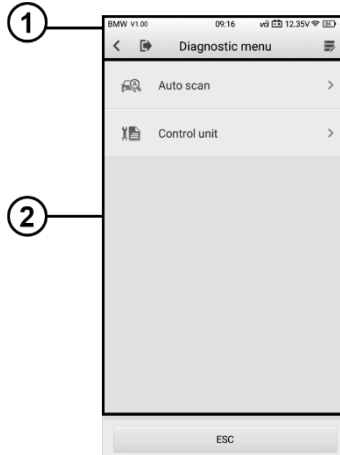

Figure 8-8 Diagnostics Screen

The diagnostic screens typically include two sections.

1. Diagnostics Toolbar
2. Main Section

8.3.1.1 Diagnostics Toolbar

The Diagnostics Toolbar contains a number of buttons such as Home and Data Logging. Refer to [Table 4-2 Top Toolbar Buttons on Service Menu](#) for details.

8.3.1.2 Main Section

The Main Section of the screen varies depending on the stage of operations. The Main Section can display vehicle identification selections, the main menu, test data, messages, instructions, and other diagnostic information.

8.3.2 Screen Messages

Screen messages appear when additional input is needed before proceeding. There are mainly three main types of on-screen messages: Confirmation, Warning, and Error.

8.3.2.1 Confirmation Messages

This type of messages usually displays as an “Information” screen, to inform the user that a selected action cannot be reversed or when an action has been initiated and confirmation is needed to continue.

When a user-response is not required to continue, the message displays briefly.

8.3.2.2 Warning Messages

This type of messages displays a warning that a selected action may result in an irreversible change or loss of data. An example of this type of message is the “Erase Codes” message.

8.3.2.3 Error Messages

Error messages display when a system or procedural error has occurred. Examples of possible errors include a disconnection or communication interruption.

8.3.3 Making Selections

The Diagnostics application is a menu-driven program that presents a series of choices. As a selection is made, the next menu in the series displays. Each selection narrows the focus and leads to the desired test. Tap the screen to make menu selections.

8.4 Diagnostics Functions

The Diagnostics application enables a data link to the electronic control system of the test vehicle for vehicle diagnosis or service. The application performs functional tests, retrieves vehicle diagnostic information such as read codes and live data from various vehicle control systems such as engine, transmission, and ABS.

There are two options available when accessing to the diagnostics functions:

- Auto Scan — starts auto scanning for all the available systems on the test vehicle.
- Control Units — displays a selection menu of all available control units on the test vehicle.

After a section is made and the tablet establishes communication with the vehicle, the corresponding function menu or selection menu displays.

Auto Scan

The Auto Scan function performs a comprehensive scanning of all the systems on the vehicle's ECU to locate systems faults and retrieve DTCs. An example of the Auto Scan interface is pictured below.

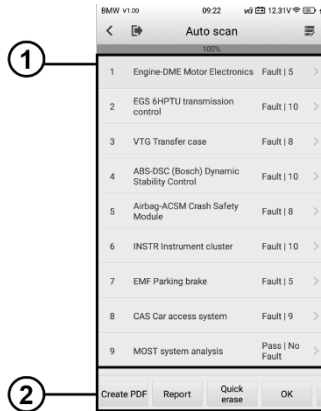

Figure 8-9 Auto Scan Operation Screen

1. Main Section
2. Function Buttons

8.4.1 Auto Scan Operation

8.4.1.1 Main Section

Column 1 — displays the system numbers.

Column 2 — displays the scanned systems.

Column 3 — displays the diagnostic indicators describing test results. These indicators are defined as follows:

- ❖ **Fault | #:** Indicates there is/are detected fault code(s) present; “#” indicates the number of the detected faults.
- ❖ **Pass | No Fault:** Indicates the system has passed the scanning process and no fault has been detected.

Column 4 — to perform further diagnosis or testing on a specific system item, tap > to the right of that item. A Function Menu screen will display.

8.4.1.2 Function Buttons

A brief description of the operations of the function buttons in auto scan are displayed in the table below.

Table 8-1 Function Buttons in Auto Scan

Name	Description
Create PDF	Creates PDFs for data viewing.
Report	Displays the diagnostic data in the report form.
Quick Erase	Deletes codes. A warning message screen will display to inform you of possible data loss when this function is selected.
OK	Confirms the test result. Continues to the system diagnosis after required system is selected by tapping the item in the Main Section.
Pause	Suspends scanning and changes to show the Continue button.
ESC	Returns to the previous screen or exit Auto Scan.

Control Units

Manually locate a required control system for testing through a series of selection choices. Follow the menu-driven procedure and make proper selections; the application guides the user to the proper diagnostic function menu based on selections.

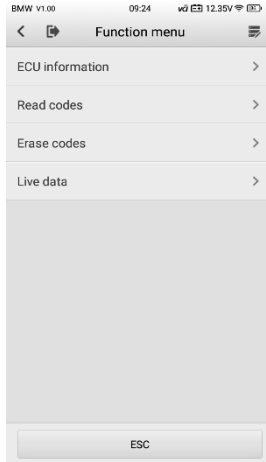

Figure 8-10 Function Menu Screen

The Function Menu options vary slightly for different vehicles. The function menu may include:

- ECU Information — provides the retrieved ECU information in detail. An information screen opens upon selection.
- Read Codes — displays detailed information of DTCs retrieved from the vehicle control module.
- Erase Codes — erases DTCs and other data from the ECU.
- Live Data — retrieves and displays live data and parameters from the vehicle's ECU.

NOTE

Toolbar functions such as saving and printing of test results can be performed throughout diagnostic testing. Data logging and access to help information are also available.

➤ **To perform a diagnostic function**

1. Establish a communication with the test vehicle.
2. Identify the test vehicle by selecting from the menu options.
3. Select the **Diagnosis** section.
4. Locate the required system for testing by **Auto Scan** or through menu driven selections in **Control Units**.
5. Select the desired diagnostics function from the **Function Menu**.

8.4.2 ECU Information

This function retrieves and displays the specific information for the tested control unit, including unit type, version numbers, and other specifications.

The sample ECU Information screen displays as below:

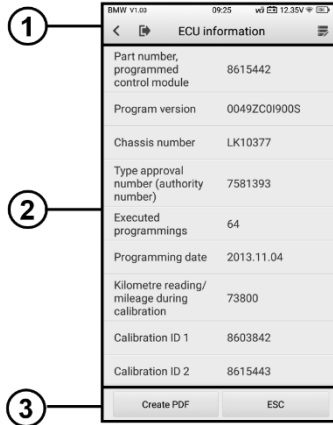

Figure 8-11 ECU Information Screen

1. Diagnostics Toolbar Buttons — see [Table 4-2 Top Toolbar Buttons on Service Menu](#) for details.
2. Main Section — the left column displays the item names; the right column shows the specifications or descriptions.
3. Function Buttons — **Create PDF** and **ESC** (or sometimes a **Back**) buttons are available.

8.4.3 Read Codes

This function retrieves and displays the DTCs from the vehicle's control system. The Read Codes screen varies for each vehicle being tested. On some vehicles, freeze frame data can also be retrieved for viewing. The sample Read Codes screen displays as below.

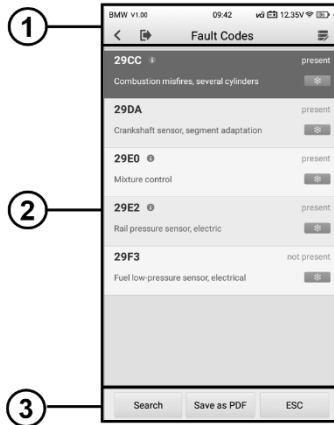

Figure 8-12 Read Codes Screen

1. Diagnostics Toolbar Buttons – see [Table 4-2 Top Toolbar Buttons on Service Menu](#) for details.
2. Main Section
 - Code Display Area — displays the retrieved codes from the vehicle.
 - Description — detailed descriptions of the retrieved codes.
 - Status — indicates the status of the retrieved codes.
 - Information Icon — tap to view fault code information, including fault description, condition for fault identification, driver information.
 - Snowflake Icon — displays when freeze frame data is available for viewing; Selecting this icon will display a data screen.
3. Function Buttons
 - Search — tap search for related fault code information on Google.
 - Save as PDF — tap to save the data in PDF format.
 - ESC — tap to return to the previous screen or exit the function.

8.4.4 Erase Codes

After reading the retrieved codes and making appropriate vehicle repairs, use this function to erase vehicle codes.

Before performing this function, make sure the vehicle's ignition key is in the ON (RUN)

position with the engine off.

➤ **To erase codes**

1. Tap **Erase Codes** from the Function Menu.
2. A warning message displays to advice of data loss if this function is completed.
 - a) Tap **Yes** to continue. A confirming screen displays when the operation is successfully done.
 - b) Tap **No** to go back to the Function menu.
3. Tap **ESC** on the function menu to exit Erase Codes.
4. Perform the Read Codes function again to check if the code has been erased successfully.

8.4.5 Live Data

When this function is selected, the screen displays the data list for the selected module. The items available for any control module vary depending on vehicle. The parameters display in the order that they are transmitted by the ECM, so expect variation between vehicles.

Gesture scrolling allows for quick movement through data list. Using one or two fingers, simply swipe the screen up or down to locate the data you want. The figure below shows a typical Live Data screen.

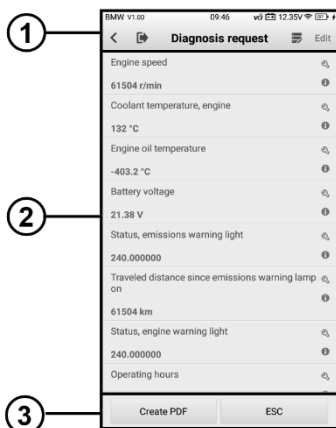

Figure 8-13 Live Data Screen

1. Diagnostics Toolbar Buttons – see [Table 4-2 Top Toolbar Buttons on Service Menu](#) for details.
2. Main Section
 - Name Display Area — displays the names and current values of the parameter items.
 - a) Settings Icon — tap the settings icon at the right side of the parameter name to select a data display mode and set the value range.
 - b) Information Icon — tap the information icon at the right side of the parameter name to view more information.
 - Display Mode

There are three types of display modes available for data viewing. Select the proper mode for diagnostic purpose.

Tapping the **Settings** icon on the right side of the parameter name to access the details of data stream page. There are three buttons to configure the data display mode, and a **Restore Default Settings** button to return to default settings.

Each parameter item displays the selected mode independently.

Analog Gauge Mode — displays the parameters in the form of an analog meter graph.

Text Mode — this is the default mode that displays the parameters in texts, displaying in a list format.

 **NOTE**

Status parameters, such as a switch reading, can primarily be viewed in test form such as ON, OFF, ACTIVE, and ABORT. Whereas, value parameters, such as a sensor reading, can be displayed in text mode and additional graph modes.

Waveform Graph Mode — displays the parameters in waveform graphs.

3. Function Buttons

The operations of available function buttons on Live Data screen are described below:

Create PDF — creates a printable live data PDF file.

ESC — returns to the Function Menu.

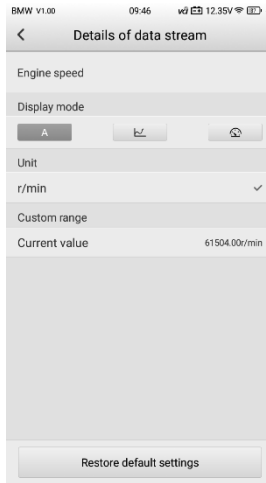

Figure 8-14 *Details of Data Stream Screen*

8.5 Generic OBDII Operations

This option presents a quick way to check for DTCs, isolate the cause of an illuminated malfunction indicator lamp (MIL), check monitor status prior to emissions certification testing and perform a number of other services that are emissions-related. The OBD direct access option is also used for testing OBDII/EOBD compliant vehicles that are not included in the database.

The diagnostics toolbar buttons at the top of the screen function the same as those available for specific vehicle diagnostics. See [Table 4-2 Top Toolbar Buttons on Service Menu](#) for details.

8.5.1 General Procedure

➤ **To access the OBDII/EOBD diagnostics functions**

1. Tap the **Diagnostics** application button on the MaxiTPMS Job Menu. The Vehicle Menu displays.
2. Tap the **EOBD** button. There are two options to establish communication with the vehicle.
 - Auto Scan — when this option is selected, the diagnostic tool attempts to establish communication using each protocol in order to determine the one from which the vehicle is broadcasting.
 - Protocols — when this option is selected, the screen displays a sub menu

listing various protocols. A communication protocol is a standardized way of data communication between an ECM and a diagnostic tool. Global OBD may use several different communication protocols.

3. Select a specific protocol under the **Protocol** option. Wait for the OBDII Diagnostic Menu to display.

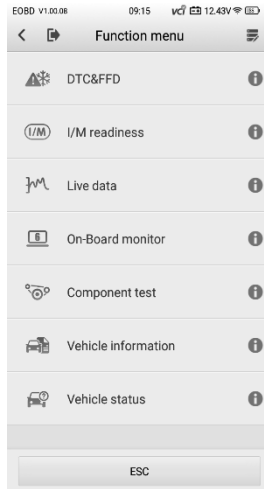

Figure 8-15 OBDII Diagnostic Menu

NOTE

Tap the **i** button beside the function name to an information bubble with additional function information.

4. Select a function option to continue.
 - DTC & FFD
 - I/M Readiness
 - Live Data
 - O2 Sensor Monitor
 - On-Board Monitor
 - Component Test
 - Vehicle Information
 - Vehicle Status

NOTE

Not all functions are supported by all vehicles.

8.5.2 Function Descriptions

This section describes the various functions of each diagnostic option.

8.5.2.1 DTC & FFD

When this function is selected, the screen displays a list of Stored and Pending Codes. A snowflake button will display on the right side of the DTC item if the Freeze Frame data is available for viewing. Tap **Clear DTC** to erase codes.

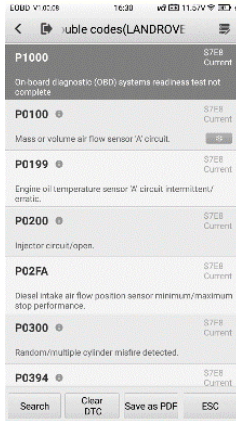

Figure 8-16 DTC & FFD Screen

- **Stored Codes**

Stored codes are the current emission-related DTCs from the ECM of the vehicle. OBDII/EOBD Codes have a priority according to their emission severity, with higher priority codes overwriting lower priority codes. The priority of the code determines the illumination of the MIL and the codes erase procedure. Manufacturers rank codes differently, so expect to see differences between makes.

- **Pending Codes**

These are codes that were generated during the last drive cycle, but before the DTC actually sets two or more consecutive drive cycles are needed. The intended use of this service is to assist the service technician after a vehicle repair and after clearing diagnostic information by reporting test results after a driving cycle.

- a) If a test failed during the drive cycle, the DTC associated with that test is reported. If the pending fault does not occur again within 40 to 80 warm-up cycles, the fault is automatically cleared from memory.

b) Test results reported by this service do not necessarily indicate a faulty component or system. If test results indicate another failure after additional driving, then a DTC is set to indicate a faulty component or system and the MIL is illuminated.

- **Freeze Frame**

Typically, the stored frame is the last DTC that occurred. Certain DTCs, that have a greater impact on vehicle emission, have a higher priority. In these cases, the top prioritized DTC is the one for which the freeze frame records are retained. Freeze frame data includes a “snapshot” of critical parameter values at the time the DTC is set.

- **Erase Codes**

This option is used to clear all emission related diagnostic data such as DTCs, freeze frame data and manufacturer-specific enhanced data from the vehicle’s ECM, and reset the I/M Readiness Monitor Status for all vehicle monitors to Not Ready or Not Complete status.

A confirmation screen displays when the clear codes option is selected to prevent accidental loss of data. Select **Yes** on the confirmation screen to continue or **No** to exit.

8.5.2.2 I/M Readiness

This function is used to check the readiness of the monitoring system. It is an excellent function to use prior to having a vehicle inspected for state emissions compliance. Select I/M Readiness to display a sub menu with two choices:

- Since DTCs Cleared — displays the status of monitors since the last time the DTCs are erased.
- This Driving Cycle — displays the status of monitors since the beginning of the current drive cycle.

8.5.2.3 Live Data

This function displays the real time PID data from ECU. Displayed data includes analog inputs and outputs, digital inputs and outputs, and system status information broadcast on the vehicle data stream.

Live data can be displayed in various modes, see [Live Data](#) for detailed information.

8.5.2.4 O2 Sensor Monitor

This option allows retrieval and viewing of O2 sensor monitor test results for the most recently performed tests from the vehicle's on-board computer.

The O2 Sensor Monitor test function is not supported by vehicles that communicate using a controller area network (CAN). For O2 Sensor Monitor tests results of CAN-equipped vehicles, refer to [On-Board Monitor](#).

8.5.2.5 On-Board Monitor

Use this option to view the results of On-Board Monitor tests. The tests are useful after servicing or after erasing a vehicle's control module memory.

8.5.2.6 Component Test

This service enables bi-directional control of the ECM so that the diagnostic tool is able to transmit control commands to operate the vehicle systems. This function is useful in determining whether the ECM responds to a command.

8.5.2.7 Vehicle Information

The option displays the VIN, the calibration identification, and the calibration verification number (CVN), and other information of the test vehicle.

8.5.2.8 Vehicle Status

This option is used to check the current condition of the vehicle, including communication protocols of OBDII modules, retrieved codes amount, status of the Malfunction Indicator Light (MIL), and other additional information.

8.6 Exiting Diagnostics

The Diagnostics application remains open as long as there is an active communication with the vehicle. Exit the diagnostics operation interface to stop all communications with the vehicle before closing the Diagnostics application.

NOTE

Damage to the vehicle electronic control module (ECM) may occur if communication is disrupted. Make sure all connections, such as USB cable and wireless connection, are properly connected at all times during testing. Exit all tests before disconnecting the test connection or powering down the tool.

➤ **To exit the Diagnostics application**

1. From an active Diagnostics screen, tap the **Back** or **ESC** function button to exit a diagnostic session.
2. From the Vehicle Menu screen, tap the **Home** button on the top toolbar; or tap the **Back** button on the navigation bar at the bottom of the screen to exit the application directly and go back to the MaxiTPMS Job Menu.

Now, the Diagnostics application is no longer communicating with the vehicle and it is safe to open other MaxiTPMS applications.

9 Service

The Service application is specially designed to provide quick access to the vehicle systems for various scheduled service and maintenance tasks. The typical service operation screen is a series of menu-driven executive commands. Follow the on-screen instructions to select appropriate execution options, enter correct values or data, and perform necessary actions. The application will display detailed instructions to complete selected service operations.

Currently, the following service functions are available:

- Oil Reset Service
- EPB Service
- BMS Service
- SAS Calibration Service
- Other functions are available with update purchase

9.1 Oil Reset Service

This function performs reset of the Engine Oil Life system, which calculates the optimal oil life change interval depending on the vehicle driving conditions and climate. The Oil Life Reminder must be reset each time the oil is changed, so the system can calculate when the next oil change is required.

NOTE

1. Always reset the engine oil life to 100% after every oil change.
 2. All required work must be carried out before the service indicators are reset. Failure to do so may result in incorrect service values and cause DTCs to be stored by the relevant control module.
 3. For some vehicles, the tool can reset additional service lights such as the maintenance cycle and service interval. On BMW vehicles for example, service resets include engine oil, spark plugs, front/rear brakes, coolant, particle filter, brake fluid, micro filter, vehicle inspection, exhaust emissions inspection and vehicle checks.
-

9.2 Electric Parking Brake (EPB) Service

This function has a multitude of usages to maintain the electronic braking system safely and effectively. The applications include deactivating and activating the brake control system, assisting with brake fluid control, opening and closing brake pads, and setting brakes after disc or pad replacement.

9.2.1 EPB Safety

It can be dangerous to perform Electric Parking Brake (EPB) system maintenance, so before you begin the service work, please keep these rules in mind:

- ✓ Ensure that you are fully familiar with the braking system and its operation before commencing any work.
- ✓ The EPB control system may be required to be deactivated before carrying out any maintenance/diagnostic work on the brake system. This can be done from the tool menu.
- ✓ Only perform maintenance work when the vehicle is stationary and on level ground.
- ✓ Ensure that the EPB control system is reactivated after the maintenance work has been completed.

NOTE

Autel accepts no responsibility for any accident or injury arising from the maintenance of the Electric Parking Brake system.

9.3 Battery Management System (BMS) Service

The Battery Management System (BMS) allows the tool to evaluate the battery charge state, monitor the close-circuit current, register the battery replacement, activate the rest state of the vehicle, and charge the battery via the diagnostic socket.

NOTE

1. This function is not supported by all vehicles.
 2. The sub functions and actual test screens of the BMS may vary by vehicle, please follow the on-screen instructions to make correct selections.
-

The vehicle may use either a sealed lead-acid battery or an AGM (Absorbed Glass Mat) battery. Lead acid battery contains liquid sulphuric acid and can spill when overturned. AGM battery (known as VRLA battery, valve regulated lead acid) also contains sulphuric acid, but the acid is contained in glass mats between terminal plates.

It is recommended that the replacement aftermarket battery has the same specifications, such as capacity and type, as the exiting battery. If the original battery is replaced with a

different type of battery (e.g. a lead-acid battery is replaced with an AGM battery) or a battery with a different capacity (mAh), the vehicle may require reprogramming of the new battery type, in addition to, performing the battery reset. Consult the vehicle manual for additional vehicle-specific information.

9.4 Steering Angle Sensor (SAS) Service

Steering Angle Sensor Calibration permanently stores the current steering wheel position as the straight-ahead position in the steering angle sensor EEPROM. Therefore, the front wheels and the steering wheel must be set exactly to the straight-ahead position before calibration. In addition, the vehicle identification number (VIN) is also read from the instrument cluster and stored permanently in the steering angle sensor EEPROM. On successful completion of calibration, the steering angle sensor fault memory is automatically cleared.

Calibration must always be carried out after the following operations:

- Steering wheel replacement.
- Steering angle sensor replacement.
- Any maintenance that involves opening the connector hub from the steering angle sensor to the column.
- Any maintenance or repair work on the steering linkage, steering gear or other related mechanism.
- Wheel alignment or wheel track adjustment.
- Accident repairs where damage to the steering angle sensor, SAS assembly, or any part of the steering system may have occurred.

NOTE

1. Autel accepts no responsibility for any accident or injury arising from servicing the SAS system. When interpreting DTCs retrieved from the vehicle, always follow the manufacturer's recommendation for repair.
 2. All software screens shown in this manual are examples, actual test screens may vary by test vehicle. Pay attention to the menu titles and onscreen instructions to make correct selections.
 3. Before starting any procedure, make sure vehicle has an ESC button. Look for button on dash.
-

10 Tire DOT

The Tire DOT application contains the following parts: **Tire Registration**, **Tire Recall Lookup** and **Tire Age Check** functions.

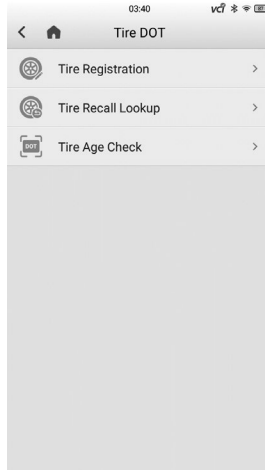

Figure 10-1 *Tire DOT* Screen

- **Tire Registration** — allows you to register E-tires by following the on-screen instructions. After the registration, you can perform DOT accuracy assist and safety recall check, register all brands sold, and view history and reporting.

Welcome to CIMS E-Tire Registration

- DOT Accuracy Assist
- Safety Recall Check
- Register All Brands Sold
- History and Reporting

Log In

Email

Password

Remember me?
Forgot your password?

Figure 10-2 Tire Registration Screen

- **Tire Recall Lookup** — detects tire status of the test vehicle. When the DOT number on a tire is scanned or automatically entered, the information of tire age, warning, and recall status will display on the screen.

10:01 vcl * * * * *

< Home Tire Recall Lookup

DOT

Age:

Warning:

Recall status

Figure 10-3 Tire Recall Lookup Screen

- **Tire Age Check** — displays tire status of the test vehicle. When the DOT number on a tire is scanned or automatically entered, the information of tire age and warning will display on the screen.

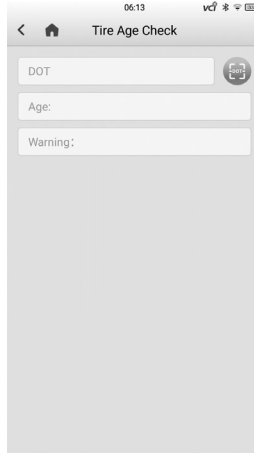

Figure 10-4 Tire Age Check Screen

NOTE

The Tire Registration and Tire Recall Lookup functions are only supported in North American region.

11 Settings

Access the Settings menu to adjust default settings and view information about the MaxiTPMS system. The following options are available for the MaxiTPMS system settings:

- TPMS Market
- TPMS Prog. Setting
- TBE Manager
- VCI Manager
- System Settings
- Printer Manager
- Report Upload to Cloud
- Unit
- About

This section describes the procedures to adjust the device's system settings.

11.1 TPMS Market

This option allows you to select the area of work, Europe, North America, Korea, Japan, or Australia.

11.2 TPMS Prog. Setting

The TPMS Prog. Setting option allows you to change the tire pressure limit for sensor programming. To reduce sensor program error, the MaxiTPMS tablet sets the sensor pressure limit to below 69 kPa by default.

11.3 TBE Manager

The TBE Manager option is for connecting the MaxiTPMS tablet with a TBE device via Wi-Fi direct mode. Make sure to turn on the Wi-Fi-direct function.

- **To connect the TBE device with the tablet via Wi-Fi direct mode**
 1. On the TBE device, tap **Settings > Network connection**. Connect to Wi-Fi first and swipe the Wi-Fi direct toggle to turn the Wi-Fi direct mode on.
 2. On the tablet, tap **Settings > TBE Manager** to access the TBE Manager screen.
 3. Tap **Scan** at the upper-right corner of the tablet's screen. The tablet will automatically search for available TBE devices.
 4. The name of the device will appear. Select the device for connection. Tap the device name to establish a communication link.
 5. A message showing "Connect Successfully" displays after the connection is established.
 6. To disconnect the device, tap the connected device listing again.
 7. Tap < on the top-left to return to the Settings Menu.

NOTE
 To ensure quick connection, please perform this operation when the MaxiTPMS tablet is connected to a steady network.

11.4 VCI Manager

This option pairs the tablet with the MaxiVCI V200E. Checks the communication status and updates the VCI firmware.



Figure 11-1 VCI Manager Screen

1. Connection Mode — there are two connection modes available for selection.
 - **Bluetooth** — when paired to a wireless device, the connection state displays as “Paired”, otherwise, it displays as “Unpaired.”
 - **Firmware Upgrade** — updates the V200E with the latest version of firmware via the Internet.
2. Bluetooth Listing

The list section displays the serial numbers for all VCI devices available for pairing. Tap a VCI device to start pairing. The BT status icon displayed to the left of the device name indicates the received signal strength.

11.4.1 Bluetooth Connection

The MaxiVCI V200E needs to be connected to the vehicle, so that it is powered during the synchronization procedure. Turn the vehicle’s ignition to the ON position. Ensure the tablet has sufficient battery power or is connected to an external power supply.

➤ To pair the MaxiVCI V200E with the tablet

1. Power on the tablet.
2. Insert the 16-pin vehicle data connector of the MaxiVCI V200E to the vehicle data link connector (DLC).
3. Tap the **Settings** application button on the MaxiTPMS Job Menu of the tablet, and select **VCI Manager**.
4. Tap **Scan** at the upper-right corner of the tablet’s screen. The device will automatically search for available pairing units.
5. The device name may display as “Maxi” suffixed with a serial number. Select the appropriate device for pairing.
6. When paired successfully, the connection status displays the device name with the message “Paired.”
7. Once paired, the VCI button on the upper-right corner of the screen will display a green check and the Connection LED on the MaxiVCI V200E illuminates solid green. This signifies that the tablet is connected to the MaxiVCI V200E, and it is ready to perform vehicle diagnosis.
8. Tap the paired device again to unpair it.
9. Tap the **Home** icon on the top-left to return to the MaxiTPMS Job Menu.

🔪 NOTE

A MaxiVCI V200E can be paired to only one tablet at a time, and once it’s paired, the device will not be discoverable to other devices.

11.4.2 VCI Firmware Upgrade

The V200E support firmware upgrade via either Bluetooth or a USB cable.

11.4.2.1 Update via Bluetooth

Before updating the V200E software, ensure the tablet's network connection to the Internet is stable.

➤ **To update the MaxiVCI V200E firmware via Bluetooth**

1. Connect the V200E to the vehicle or charge it with an adapter before pairing it with the tablet via Bluetooth.
2. On the MaxiTPMS Job Menu, tap **Settings > VCI Manager**, and select the **Bluetooth** button on the top-left corner of the screen. Pair the tablet with V200E by tapping the device's serial number on the screen.
3. When the pairing is successful, the connection status displays as connected.
4. Tap **Firmware upgrade > Detect Firmware** to check if an update for the V200E is available.

11.4.2.2 Update via USB Cable

When the V200E is connected with the tablet using a Type-C to Type-C USB cable, tap **Firmware upgrade > Detect Firmware Version** to check if an update is available.

11.5 System Settings

This function provides you with direct access to the System Settings screen, where you can adjust various system settings for the tablet, including wireless and networks settings, various device settings such as sound, display, and language settings.

11.6 Printer Manager

The Printer Manager function enables you to switch the way for report printing. There are two printing methods available:

- Printing via PC Link
- Printing via Wi-Fi

11.7 Report Upload to Cloud

Toggle the ON/OFF button to enable or disable the Report Upload to Cloud function. If the button displays blue, it indicates the function is enabled. If the button displays gray, it

indicates the function is disabled.

11.8 Unit

This option allows you to adjust the measurement unit for the diagnostic system.

➤ **To adjust the unit setting**

1. Tap the **Settings** application button on the MaxiTPMS Job Menu.
2. Tap the **Unit** option.
3. Select the desired measurement unit. A check mark will display to the right of the selected unit.
4. Tap the **Home** button on the top-left corner to return to the MaxiTPMS Job Menu.

11.9 About

The About section displays information regarding the MaxiTPMS tablet, including the password, system version, hardware version, and the device's serial number.

➤ **To check the MaxiTPMS product information in About**

1. Tap the **Settings** application button on the MaxiTPMS Job Menu.
2. Tap **About** to open the product information screen.
3. Tap **Home** on the top-left corner to return to the MaxiTPMS Job Menu.

12 ToolKit

This chapter describes auxiliary functions for TPMS service and vehicle diagnosis.

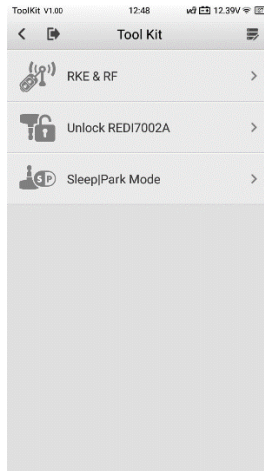

Figure 12-1 ToolKit Screen

- **RKE & RF** — this function is used to check the signal strength of 315 and 433 MHz frequencies of remote keyless entry Fobs.
- **Unlock REDI7002A** — this function is used to unlock the specified Redi-sensor: 7002A.
- **Sleep/Park Mode** — for those OEM sensors that are delivered in Sleep Mode, this function is used to wake and set them to Park Mode.

13 Update

This chapter describes the update operation for the MaxiTPMS tablet. The software updates can be completed on the tablet via the Internet.

13.1 Tablet Update

The Update application allows you to download the latest released software. The updates can improve the MaxiTPMS applications' capabilities, typically by adding new vehicle models, TPMS service functions, etc.

The device automatically searches for available updates for all of the MaxiTPMS components when it is connected to the Internet. Any updates that are found can be downloaded and installed on the device. This section describes installing an update to the MaxiTPMS System software. Tap the **Activate Pro Function** button at the bottom of the screen for all systems diagnostics and service function with an additional in-app purchase.

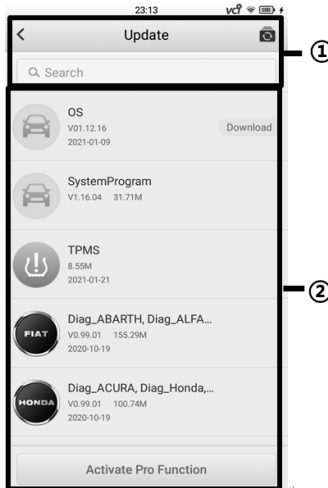

Figure 13-1 Update Screen



1. Navigation and Controls
 - Return Button — returns to the MaxiTPMS Job Menu.
 - Update All — downloads all available updates.

- Search Bar — searches specific update item by inputting the file name. Example: enter a vehicle manufacturer.

2. Main Section

- Left Column — displays TPMS button and manufacturer buttons.
 TPMS Button — downloads the TPMS service software for all available vehicles.
 Manufacturer Buttons — downloads the manufacturer specific service software.
- Middle Column — displays update software version and a brief introduction about the new changes to the software operation or capabilities. Tap the vehicle brand of your selection to open an information screen to view more details.
- Right Column — displays update button, which also works as an update progress bar indicating the completion status in percentage when downloading the software selected.

➤ To update the TPMS service software and diagnostics software

1. Ensure the tablet is connected to a power source and has a stable connection with the Internet.
2. Tap the **Update** application button from the MaxiTPMS Job Menu; the Update screen displays. Tap  button on the upper right corner to have all the downloadable items in updating status. This will also update all the items at once if not second tap  button to suspend or resume the updating process.
3. If you only want to update one or some of the item(s), tap the **Download** button on the right column of the specific item(s).
4. Second tap the **Download** button to suspend or resume the updating process.
5. When the updating process is complete, the software will be installed automatically. The previous version will be replaced.

There is NO separate download button for the tablet's software. The software is downloaded with the software package.

14 Data Manager







The Data Manager application allows you to store, print, and review saved files, manage workshop information and keep test vehicle history records.

Selecting the Data Manager application opens the menu page which contains seven main functions:

- Test Records
- Workshop Information
- Image
- PDF
- Report
- Uninstall Apps
- Data Logging

The following table briefly describes the toolbar buttons used to perform these functions.

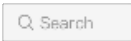
Table 14-1 *Toolbar Buttons on the Data Manager Screen*

Button	Name	Description
	Back	Returns to the previous screen.
	Home	Returns to the Job Menu screen.
	Edit	Tap this button to edit information for the displayed file.
	Delete	Tap this button to delete the selected vehicle record.
	Search	Enter the vehicle name or test path to retrieve vehicle record.
	Cancel	Tap this button to cancel editing or file search.

14.1 Test Records

This function stores test vehicle history records, in terms of TPMS, TPMS retrofit, Service, and Diagnostics-related information from the previous diagnostics and TPMS sessions. All information is displayed in summarized details. Tap on a record to resume a diagnostic or TPMS session on a “stored vehicle.”

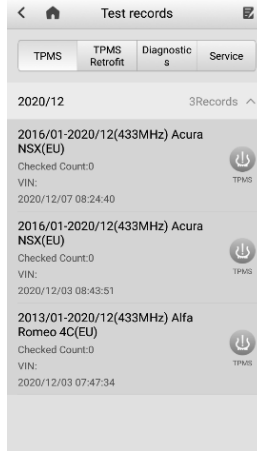





Figure 14-1 Test Records Screen

- **To activate a test session for the recorded vehicle**
 1. Tap the **Data Manager** application button on the MaxiTPMS Job Menu.
 2. Select **Test records** and choose a functional tab to display a list of thumbnails.
 3. Tap the function icon on the right side of a thumbnail of a vehicle record item to view the related test record. For details, see [Table 14-2 Function Buttons on the Test Records Screen](#).
 4. Or, directly tap the vehicle record thumbnail to view TPMS test report.
 5. A TPMS test report displays, tap on each item to input the corresponding information or add relevant files or images.
 6. The updated test report will be automatically saved.
 7. Print the selected TPMS test report or send it via email.

NOTE

The VIN or license number and the customer information account are correlated by default.

Table 14-2 Function Buttons on the Test Records Screen

Button	Name	Description
	Diagnostics	Displays the previous diagnostics session.
	TPMS	Displays the previous TPMS session.
	TPMS Retrofit	Displays the previous TPMS retrofit session.
	Service	Displays the previous service session, including oil reset, BMS, and other services.

14.1.1 TPMS Test Report

The TPMS test report is a detailed data form that includes general vehicle information such as vehicle year, make and model. The form also includes information on TPMS-related DTCs, workshop, and all information manually entered by the technician.

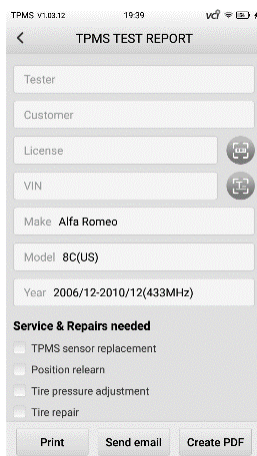

Figure 14-2 TPMS TEST REPORT Screen

A report can be printed in two ways, print via PC Link or via Wi-Fi.

14.1.1.1 Printing via PC Link

You can use your computer to print the data on the tablet. Follow the instructions below to operate.

➤ To install the PC Link driver program

1. Download the **Maxi PC Suite** from www.autel.com > **Support** > **Downloads** > **Diagnostic Tool** > **Autel Update Tools**, and install to your PC.
2. Double click the **Setup.exe**.
3. Select the installation language and the wizard will load momentarily.
4. Follow the instructions on the screen, and click **Next** to continue.
5. Click **Install**. The PC Link program will be installed into the computer.
6. Click **Finish** to complete the installation.

NOTE

1. The PC Link print program only supports Windows system, so please install the PC Link program in a Windows-based computer.
2. Prior to installing the PC Link program, please confirm whether Adobe software is installed in your computer. If not, install Adobe software first.

➤ To print a report via PC Link

1. Run the PC Link program on your computer.
2. Select the **MaxiSys Printer** tab.
3. Tap the **Print** icon on the tablet. A report will be sent to the computer.
 - If the **Auto Print** option in the MaxiSys Printer is selected, the received report will be printed out automatically.
 - If the **Auto Print** option in the MaxiSys Printer is not selected, click **Open PDF File** to view all the temporary files. Select the file(s) needed for printing, then tap **Print**.

NOTE



1. To confirm that the printer is functioning normally, you can click **Test Print** in the PC Link program to test.
 2. Make sure the tablet is connected to the same network with your computer, either via Wi-Fi or LAN, before printing.
-

14.1.1.2 Printing via Wi-Fi

➤ To print a report via Wi-Fi

1. Turn on your own Wi-Fi printer.
2. Power up the tablet. Swipe down from the top of the screen to display the shortcuts panel. Toggle the **WLAN** icon to ON, then connect the tablet to the

printer via Wi-Fi.

3. On a tablet screen where the printing function is available, tap the **Print** icon, then select **Print via Wi-Fi**.
4. The tablet will automatically generate a PDF file. Tap the dropdown button , then select the printer you need. And next, tap the **Print** icon  on the screen. The printer will automatically receive and print the generated PDF file.

14.2 Workshop Information

Use the Workshop Information form to edit, input, and save the detailed workshop information, such as header image, store picture, shop name, address, phone number and other remarks, which when printing vehicle diagnostic reports and other associated test file, will display as the header of the printed documents.

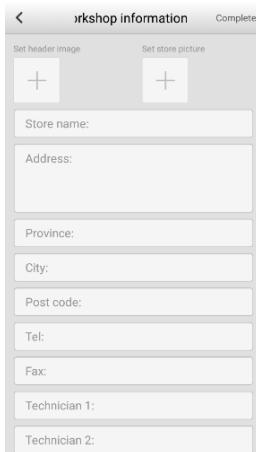

Figure 14-3 Workshop Information Sheet

➤ **To edit the Workshop Information sheet**

1. Tap the **Data Manager** application button on the MaxiTPMS Job Menu.
2. Select **Workshop Information**.
3. Tap each field to input the appropriate information.
4. Tap **Return** to save the updated workshop information sheet, or tap **Back** on the upper-left corner to exit without saving.

14.3 Image

The Image section contains all captured screenshot images and images taken by the high-resolution camera.

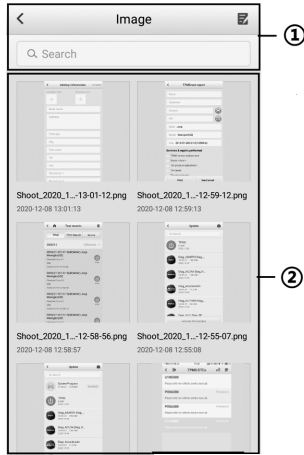







Figure 14-4 Image Screen

1. **Toolbar Buttons** — used to delete the image files and go back to the previous screen. For details, see [Table 14-3 Toolbar Buttons on Image Screen](#).
2. **Main Section** — displays the stored images.

Table 14-3 Toolbar Buttons on Image Screen

Button	Name	Description
	Back	Returns to the previous screen.
	Edit	Tap this button to display the editing options. Select, delete, or view image information.
	Cancel	Tap this button to close the editing toolbar or cancel file search.

Button	Name	Description
	Search	Quickly locates the image file by entering the vehicle name, test path, file name or file info.
	Delete	Tap this button to delete the selected image.
	Details	Tap this button to display image details.
	Send email	Tap this button to send the selected image via email.
	Print	Tap this button to print the selected image.
	Rename	Tap this button to rename the screenshot selected.

➤ **To delete selected images**

1. Tap the **Data Manager** application button on the MaxiTPMS Job Menu.
2. Select **Image** to access the image database.
3. Tap the **Edit** icon on the upper-right corner.
4. Select the images that need to be deleted by tapping the blank check boxes of the thumbnail images. The selected thumbnail displays a green check mark at the bottom-right corner.
5. Tap the **Delete** button, then tap **OK**. The selected images will be deleted.
6. Or, simply select an image to display in full screen, and select the **Delete** button at the bottom to delete this specific image.

14.4 PDF

The PDF files designated for local viewing are displayed in this section. Select a PDF from the database to display.

The standard Adobe Reader application is used for file viewing and editing. Refer to the associated Adobe Reader manual for detailed instructions.



14.5 Report

Test reports can be viewed, saved, printed, and shared in multiple applications such as TPMS, Diagnostics, and Battery Test. The saved reports will be listed in this section.

➤ **To share the cloud reports**

1. Tap the **Data Manager** application button on the MaxiTPMS Job Menu.
2. Tap **Report** to open the report list. The saved reports will be displayed.
3. Select the report that is successfully uploaded to the cloud for sharing.

 **NOTE**

If the report thumbnail displays  , it indicates the report is successfully uploaded to the cloud. If the report thumbnail displays  , it indicates the report is not uploaded to the cloud.

-
4. There are three ways to share the cloud reports: via QR code, via email, or via message.

14.6 Uninstall Apps

This function manages the applications installed on the MaxiTPMS diagnostics system. Select this to open a management screen, on which all the available vehicle diagnostic applications can be reviewed.

Tap on the vehicle manufacturer icon that you wish to delete. The selected icon will display a blue check mark at the upper-right corner. Tap the **Delete** button to delete the application from the system database.

14.7 Data Logging



The Data Logging section keeps records of all **Feedback** (submitted), **Not Feedback** (not submitted but saved) or **History** (up to the latest 20 test records) data loggings on the diagnostic system. The support personnel will receive and process the submitted reports through the Support platform. The solution will be sent back as soon as possible. You may continue to correspond with the Support platform until the issue is resolved.

Data Logging can be performed during or after a testing or a diagnostic session is done, and specifically, data logging is available in terms of TPMS, TPMS Retrofit, Diagnostics, and Service functions.

➤ **To send message to the technical center**

1. Take Data Logging of the TPMS application as an example. On the main TPMS screen, after a testing or diagnostics session is done, tap the **Data Logging**

button  on the upper-right corner of the screen to make a selection of error type.

2. Tap **OK** to open the Details screen.
3. Describe problems in details in the **Reason for Sending** section.
4. Confirm vehicle information, then tap  to upload data logs, or tap  on the upper-right corner of the screen to correct the vehicle information.

 **NOTE**

Upon completion of the data logs upload, go to **Data Manager > Data logging > History**. Find the vehicle record of your preference and send data logs for technical support.

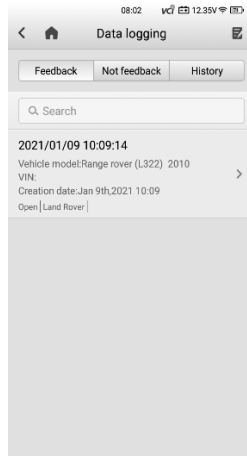

Figure 14-5 Data Logging Screen 1

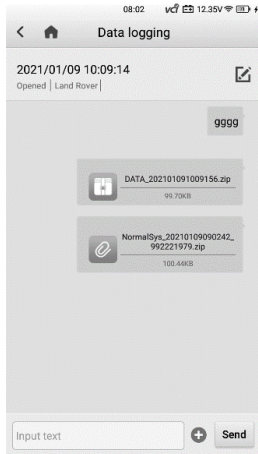

Figure 14-6 Data Logging Screen 2

➤ **To reply in a Data Logging session**

1. Tap on the **Feedback** tag to view a list of submitted data logs.
2. Select a specific item to track the progress of data log review.
3. Tap the pencil icon on the upper-right corner to correct vehicle information, or directly input text into the blank bar and tap **Send** to send your message to the technical center.

15 Academy

The Academy provides access to various onboard instructional videos and manuals produced by top-notch technicians and product experts, covering information on main functions such as TPMS Relearn and Rewrite functions. Please access the videos or articles saved on the tablet by tapping the images with hyperlinks displayed under this application.

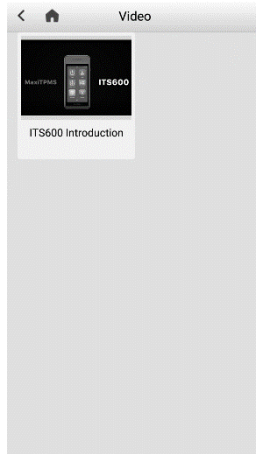

Figure 15-1 Academy Screen

16 Remote Desktop

The **Remote Desktop** application launches the TeamViewer Quick Support program, a simple, fast, and secure remote control interface. Use this application to receive ad-hoc remote support from Autel's support technicians by allowing them to control the tablet on their PC via the TeamViewer software.

17 MaxiTools

The MaxiTools application provides you with a quick entrance to access the following functions, including system tools, quick link, email, and tire DOT.

17.1 System Tools

The System Tools option allows you to perform Log and Factory Data Reset functions when there are errors related to system program issues.

➤ **To post a log collection**

1. Tap **MaxiTools > System tools > Log** from the MaxiTPMS Job Menu. The Log Collection screen displays.
2. Choose an option from the **Collection Options** section, and tap the **Start** button at left-bottom of the screen to initiate log collection.
3. Tap **Stop** to end collection, or tap **Upload** to send the logs collected to the technical center.

 **NOTE**

For easy access, directly enter the Log Collection screen via Shortcuts Panel by tapping the Logger button.

17.2 Quick Link

The Quick Link option provides access to Autel's official websites and other popular automotive service websites. These sites are invaluable resources of automotive information and repair data, which include forums, video training, and expert consultation.

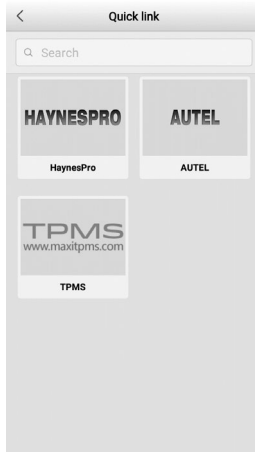

Figure 17-1 Quick Link Screen

➤ **To open a quick link**

1. Tap **MaxiTools > Quick Link** from the MaxiTPMS Job Menu. The Quick Link screen displays.
2. Select a website thumbnail on the main section. The Chrome browser is launched and the selected website is opened.

17.3 Email

The Email option enables sending and receiving emails after account registration. Simply input your email account and password to start.

18 **Activate Pro Function**

Activate Pro Function provides a quick access to upgrade the basic version of the MaxiTPMS tablet with an additional purchase. After the advanced version of the tablet is downloaded, you can perform diagnosis and service functions for all vehicle brands and systems.

19 Maintenance and Service

19.1 Maintenance Instructions

The following shows how to maintain your devices, together with precautions to take.

- Use a soft cloth and alcohol or a mild window cleaner to clean the tablet's touchscreen.
- Do not use any abrasive cleansers, detergent, or automotive chemicals on the tablet.
- Only use the device in dry conditions within normal operating temperatures.
- Dry your hands before using the tablet. The touchscreen may not work if the touchscreen is moist, or if you tap the touchscreen with wet hands.
- Do not store the devices in humid, dusty or dirty areas.
- Before and after use, check the housing, wiring, and connectors for dirt and damage.
- At the end of each work day, wipe the device housing, wiring, and connectors clean with a damp cloth.
- Do not attempt to disassemble your tablet or VCI unit.
- Take care not to drop the device or allow anything heavy to drop on the device.
- Use only authorized battery chargers and accessories. Any malfunction or damage caused by the use of unauthorized battery charger and accessories will void the limited product warranty.
- Ensure that the battery charger does not come in contact with conductive objects.
- Do not operate the tablet next to anything such as a microwave oven, cordless phone and some medical or scientific instruments that might interfere with or prevent signal interference.

19.2 Troubleshooting Checklist

- A. When the tablet does not work properly:
- Make sure the tablet has been registered online.
 - Make sure the system software and diagnostic application software are properly updated.
 - Make sure the tablet is connected to the Internet.
 - Check all cables, connections, and indicators to see if the signal is being received.

- B. When battery life is shorter than usual:
 - This may happen when you are in an area with low signal strength.
 - Turn off your device when not in use.
- C. When unable to power on the tablet:
 - Make sure the tablet is connected to a power source or the battery is charged.
- D. When unable to charge the tablet:
 - Your charger maybe out of order. Contact the seller.
 - You may be attempting to use the device in an overly hot/cold temperature. Use the tablet in an environment within normal operating temperatures.
 - Your device may have not been properly connected to the charger. Check the connector.

 **NOTE**

If your problems persist, please contact Autel's technical support.

19.3 About Battery Usage

Your tablet is powered by a built-in Lithium-ion Polymer battery. The Lithium-ion Polymer battery can recharge while some charge remains without reducing your tablet's autonomy due to the "battery memory effect" inherent in this type of battery technology.

 **DANGER**

1. The built-in Lithium-ion Polymer battery is factory replaceable only; incorrect replacement or tampering with the battery pack may cause an explosion.
 2. Do not use a damaged battery charger.
-
- Do not disassemble or open crush, bend or deform, puncture or shred.
 - Do not modify or remanufacture, attempt to insert foreign objects into the battery, expose to fire, explosion or other hazards.
 - Make sure to only use the supplied charger and USB cables. Using an unapproved charger or unapproved USB cable might not working correctly or might damage the tablet or VCI.
 - Only use the supplied charging device that has been qualified for use with the device. Use of an unqualified battery or charger may present a risk of fire, explosion, leakage or other hazards.
 - Avoid dropping the tablet. If the tablet is dropped, especially on a hard surface, and the user suspects damage, take it to a service center for inspection.
 - Working closer to the Wi-Fi router improves the working battery life of the tablet as less battery power is consumed to make connection.

- The battery recharging time varies depending on the remaining battery capacity.
- Battery life inevitably shortens over time.
- Since overcharging may shorten battery life, unplug tablet and charger from power outlet when tool is sufficiently charged.
- Leaving the tablet in hot or cold places, especially inside a vehicle in summer or winter, may reduce the battery's capacity and longevity. Always keep the battery within normal temperatures.

19.4 Service Procedures

This section introduces information for technical support, repair service, and application for replacement or optional parts.

19.4.1 Technical Support

If you have any question or problem about the operation of the product, please contact us (see the following contact info).

Autel Headquarters

- **Phone:** +86 (0755) 8614-7779 (Monday-Friday, 9AM-6PM Beijing Time)
- **Email:** supportpms@auteltech.com
- **Address:** Floor 2, Caihong Keji Building, 36 Hi-tech North Six Road, Songpingshan Community, Xili Sub-district, Nanshan District, Shenzhen City, China
- **Web:** www.autel.com; www.maxitpms.com

19.4.2 Repair Service

If it becomes necessary to return your device for repair, please contact us first and then download the repair service form from www.autel.com and www.maxitpms.com, and fill it in. The following information must be included:

- Contact name
- Return address
- Telephone number
- Product name
- Complete description of the problem
- Proof-of-purchase for warranty repairs
- Preferred method of payment for non-warranty repairs

NOTE

For non-warranty repairs, payment can be made with Visa, Master Card, or with approved credit terms.

Send the device to the below address:

Floor 2, Caihong Keji Building, 36 Hi-tech North Six Road, Songpingshan Community, Xili Sub-district, Nanshan District, Shenzhen City, China

19.4.3 Other Services

You can purchase the optional accessories directly from Autel's authorized tool suppliers.

Your purchase order should include the following information:

- Contact information
- Product or part name
- Item description
- Purchase quantity

20 Compliance Information

FCC COMPLIANCE

FCC ID: WQ8TPMS609T

This device complies with Part 15 of the FCC rules and Industry Canada's license-exempt RSSs. Operation is subject to the following two conditions:

1. This device may not cause harmful interference.
2. This device must accept any interference received, including interference that may cause undesired operation.

WARNING

Changes or modifications not expressly approved by the party responsible for compliance could void the user's authority to operate the equipment.

NOTE

This equipment has been tested and found to comply with the limits for a Class B digital device, pursuant to Part 15 of the FCC Rules. These limits are designed to provide reasonable protection against harmful interference in a residential installation.

This equipment generates, uses and can radiate radio frequency energy and, if not installed and used in accordance with the instructions, may cause harmful interference to radio communications. However, there is no guarantee that interference will not occur in a particular installation. If this equipment does cause harmful interference to radio or television reception, which can be determined by turning the equipment off and on, the user is encouraged to try to correct the interference by one or more of the following measures:

- Reorient or relocate the receiving antenna.
- Increase the separation between the equipment and receiver.
- Connect the equipment into an outlet on a circuit different from that to which the receiver is connected.
- Consult the dealer or an experienced radio/TV technician for help.

Changes or modifications not expressly approved by the party responsible for compliance could void the user's authority to operate the equipment.

SAR

The radiated output power of this device is below the FCC radio frequency exposure limits. Nevertheless, the device should be used in such a manner that the potential for human contact is minimized during normal operation.

The exposure standard for wireless devices employs a unit of measurement known as the Specific Absorption Rate, or SAR. The SAR limit set by the FCC is 1.6 W/Kg. Tests for SAR are conducted using standard operating positions accepted by the FCC with the device transmitting at its highest certified power level in all tested frequency bands.

Although the SAR is determined at the highest certified power level, the actual SAR level of the device while operating can be well below the maximum value. This is because the device is designed to operate at multiple power levels so as to use only the power required to reach the network. To avoid the possibility of exceeding the FCC radio frequency exposure limits, human proximity to antenna should be minimized.

RF WARNING STATEMENT

The device has been evaluated to meet general RF exposure requirement. The device can be used in portable exposure condition without restriction.

RoHS COMPLIANCE

This device is declared to be in compliance with the European RoHS Directive 2011/65/EU.

CE COMPLIANCE

This product is declared to conform to the essential requirements of the following Directives and carries the CE mark accordingly:

EMC Directive 2014/30/EU

R&TTE Directive 1999/5/EC

Low Voltage Directive 2014/35/EU

KC COMPLIANCE



R-C-WQ2-ITS600

21 Warranty

Limited One Year Warranty

Autel Intelligent Technology Corp., Ltd. (the Company) warrants to the original retail purchaser of this MaxiTPMS diagnostics device that should this product or any part thereof during normal usage and conditions, be proven defective in material or workmanship and results in product failure within 1 year period from the date of purchase, such defect(s) will be repaired, or replaced (with new or rebuilt parts) with Proof of Purchase, at the Company's option, without charge for parts or labor directly related to the defect(s).

NOTE

If the warranty period is inconsistent with local laws and regulations, please comply with the relevant local laws and regulations.

The Company shall not be liable for any incidental or consequential damages arising from the use, misuse, or mounting of the device. Some states do not allow limitation on how long an implied warranty lasts, so the above limitations may not apply to you.

This warranty does not apply to:

- 1) Products subjected to abnormal use or conditions, accident, mishandling, neglect, unauthorized alteration, misuse, improper installation or repair or improper storage;
- 2) Products whose mechanical serial number or electronic serial number has been removed, altered or defaced;
- 3) Damage from exposure to excessive temperatures or extreme environmental conditions;
- 4) Damage resulting from connection to, or use of any accessory or other product not approved or authorized by the Company;
- 5) Defects in appearance, cosmetic, decorative or structural items such as framing and non-operative parts;
- 6) Products damaged from external causes such as fire, dirt, sand, battery leakage, blown fuse, theft or improper usage of any electrical source.

! **IMPORTANT**

All contents of the product may be deleted during the process of repair. You should create a back-up copy of any contents of your product before delivering the product for warranty service.

AUTEL[®]